



中德能源与能效合作
Energiepartnerschaft
DEUTSCHLAND - CHINA

Supported by:



Federal Ministry
for Economic Affairs
and Energy

on the basis of a decision
by the German Bundestag

*Technical Guidelines on
Energy Efficiency in Major Energy-Consuming Sectors*

Energy Efficiency in the Pulp and Paper Industry



Imprint

The report Energy Efficiency in the Pulp and Paper Industry. Technical Guidelines on Energy Efficiency in Major Energy-Consuming Sectors is published within the framework of the “Sino-German Demonstration Project on Energy Efficiency in Industry.” The demonstration project, as part of the Sino-German Energy Partnership between the German Federal Ministry for Economic Affairs and Energy (BMWi) and the National Development and Reform Commission (NDRC), jointly implemented by Deutsche Gesellschaft für Internationale Zusammenarbeit (GIZ) GmbH and the National Energy Conservation Center (NECC), aims at carbon emissions reduction in China’s major energy-consuming sectors by providing energy efficiency measures and best practices, and strengthening private sector cooperation. The report is co-financed by the “Supporting Low Carbon Development in Jiangsu Province Project (Phase III),” which is funded by the German Federal Ministry for the Environment, Nature Conservation and Nuclear Safety (BMU) and jointly implemented by Jiangsu Department for Ecology and Environment and GIZ. As a German federal enterprise, GIZ supports the German government in the achievement of its goals in international cooperation for sustainable development.

This report is the first in series of publications to provide an overview and analysis of energy efficiency measures for key sectors including airports, and the manufacturing industries for pulp and paper, cement, ceramics, and glass fibers, drawing from German and international experiences and best practices.



SUPPORTING THE LOW CARBON DEVELOPMENT
OF JIANGSU PROVINCE
江苏低碳城市发展项目

Published by

Sino-German Demonstration Project on
Energy Efficiency in Industry

Tayuan Diplomatic Office Building 2-5,
14 Liangmahe South Street, Chaoyang District
100600 Beijing, P. R. China
c/o

Deutsche Gesellschaft für Internationale
Zusammenarbeit (GIZ) GmbH
Torsten Fritsche
Köthener Str. 2
10963 Berlin

Project Management

Maximilian Ryssel, Yihui Wang
Deutsche Gesellschaft für Internationale
Zusammenarbeit (GIZ) GmbH

Authors

Helmut Berger (coordination),
Nushin Shahri, Thomas Eisenhut,
Manuela Farghadan
ALLPLAN GmbH



Images

As stated in the document;
Shutterstock\ Jose Luis Stephens (Front Cover)
Shutterstock\ NEFLO PHOTO (P10)
Shutterstock\ seeshooteatrepeat (P14)
Shutterstock\ hxdyl (P20)
Shutterstock\ SocoXbreed (P32)
Shutterstock\ Hannu Rama (P80)

© Beijing, July 2021

This report in its entirety is protected by copyright. The information contained was compiled to the best of our knowledge and belief in accordance with the principles of good scientific practice. The authors believe the information in this report is correct, complete and current, but accept no liability for any errors, explicit or implicit. The statements in this document do not necessarily reflect the client’s opinion.

Foreword

Dear readers, colleagues and friends,

In recent years, we have seen substantial progress being made in the energy transition in Germany and China. China remains the country with the world's largest installed capacity of renewable energy, whereas in Germany, the share of renewables in the net electricity generation has exceeded 50% for the first time. But whilst the promotion and development of renewable energy plays an important role in our global measures to prevent climate change, it alone would not be sufficient to protect a liveable future for humanity. To complete the necessary energy transition, it is also crucial to improve energy efficiency in buildings, industry and transport. This is based on the simple fact that the cheapest and cleanest energy is that, which does not have to be produced in the first place.

Focusing on improving energy efficiency in industrial production is especially powerful, since industry is one of the major energy consuming segments worldwide, making up roughly 29% of total final energy consumption. In China, close to half of total final energy consumption can be attributed to industries. Furthermore, given a relatively manageable number of key industry players, there are great leverage opportunities that can be taken advantage of, in order to reduce energy consumption.

As part of its energy transition, the German Federal Government has recently set itself the target to reach climate-neutrality in all sectors by 2045. By mid-century, Germany aims to cut its primary energy consumption by 50% compared to 2008. To achieve this, Germany adopted the "efficiency first" principle, which aims at prioritising energy efficiency wherever possible.

In a similar vein, China has emphasised energy efficiency as part of its Energy Revolution Strategy (2016–2030). The 14th Five-Year-Plan set forth by the Chinese government aims to reduce energy intensity by 13.5% and carbon intensity by 18% over the 2021–2025 period. These targets are set against the backdrop of bringing carbon emissions to a peak before 2030 and achieving carbon-neutrality by 2060. To meet these ambitious goals, comprehensive reforms in industries are needed.

Here, international cooperation between Germany and China can play a contributing role. This report is published as part of the Sino-German Energy Partnership between the German Federal Ministry for Economic Affairs and Energy (BMWi), the National Development and Reform Commission (NDRC) and the National Energy Administration of the PRC (NEA), and the project "Supporting Low Carbon Development in Jiangsu Province" funded by the German Federal Ministry for the Environment, Nature Conservation and Nuclear Safety (BMU).

The report focuses on the pulp and paper industry and is the first in a series of reports on energy efficiency measures in heavy industry sectors. It highlights process-related measures in the very energy-intensive process of pulp and paper production and discusses these according to their implementation potential and effectiveness.

I would like to express my gratitude to all involved experts and implementing partners, especially the National Energy Conservation Center of the PRC (NECC) and the Jiangsu Department for Ecology and Environment, for their ongoing support. I sincerely hope that this study will contribute towards finding more energy-efficient solutions that lead us to a cleaner future and that spark further inspiration for Sino-German cooperation in industrial sectors.



Markus Delfs

Head of Cluster Sustainable
Transition,
GIZ China

Content

◆ 1	Executive Summary	10
◆ 2	Introduction on Energy Efficiency in Industry	14
2.1	Energy Consumption and Status of Energy Efficiency	15
2.2	Energy Efficiency Policy and Management	18
2.3	Overview of Energy Efficiency Measures	19
◆ 3	Overview of the Pulp and Paper Sector	20
3.1	Description of the Production Process and Process Steps	21
3.2	Current Situation and Development of Energy Efficiency in the Sector	27
3.2.1	Energy Statistics and Benchmarks Pulp & Paper	27
3.2.2	Energy Flows	30
3.2.3	Energy Intensive Processes	31
◆ 4	Sector Specific Energy Efficiency Measures	32
4.1	Batch Digester Improvement	34
4.1.1	Description of Baseline Situation and Energy Consumption	34
4.1.2	Suggested Measures of Improvement	35
4.1.3	Potential Energy Savings and Greenhouse Gas Emission Reduction	36
4.2	Lime Kiln Modification	37
4.2.1	Description of Baseline Situation and Energy Consumption	37
4.2.2	Suggested Measure of Improvement	38
4.2.3	Potential Energy Savings and Greenhouse Gas Emission Reduction	40
4.3	Black Liquor Evaporator	41
4.3.1	Description of Baseline Situation and Energy Consumption	41
4.3.2	Suggested Measure of Improvement	41
4.3.3	Potential Energy Savings and Greenhouse Gas Emission Reduction	42
4.4	Refiner Improvements	43
4.4.1	Description of Baseline Situation and Energy Consumption	43
4.4.2	Suggested Measure of Improvement	43
4.4.3	Potential Energy Savings and Greenhouse Gas Emission Reduction	44
4.5	Waste Heat Recovery	45
4.5.1	Description of Baseline Situation and Energy Consumption	45
4.5.2	Suggested Measures of Improvement	47
4.5.3	Potential Energy Savings and Greenhouse Gas Emission Reduction	48
4.6	Shoe Press	50
4.6.1	Description of Baseline Situation and Energy Consumption	50
4.6.2	Suggested Measure of Improvement	51
4.6.3	Potential Energy Savings and Greenhouse Gas Emission Reduction	53
4.7	Dryers Bars and Stationary Siphons	54
4.7.1	Description of Baseline Situation and Energy Consumption	54
4.7.2	Suggested Measure of Improvement	55
4.7.3	Potential Energy Savings and Greenhouse Gas Emission Reduction	56
4.8	Steam Traps Maintenance	57
4.8.1	Description of Baseline Situation and Energy Consumption	57
4.8.2	Suggested Measure of Improvement	58
4.8.3	Potential Energy Savings and Greenhouse Gas Emission Reduction	59

4.9	Real-Time Energy Management System	60
4.9.1	Description of Baseline Situation and Energy Consumption	60
4.9.2	Suggested Measure of Improvement	60
4.9.3	Potential Energy Savings and Greenhouse Gas Emission Reduction	61
4.10	Energy-Efficient Frequency Inverter for Pumps, Fans, and Compressors	62
4.10.1	Description of Baseline Situation and Energy Consumption	62
4.10.2	Suggested Measure of Improvement	63
4.10.3	Potential Energy Savings and Greenhouse Gas Emission Reduction	64
4.11	Utilizing Excess Heat for Drying of Biofuel and Sludge	65
4.11.1	Description of Baseline Situation and Energy Consumption	65
4.11.2	Suggested Measure of Improvement	65
4.11.3	Potential Energy Savings and Greenhouse Gas Emission Reduction	66
4.12	Waste Incineration Plant (Using Sludge and Reject)	67
4.12.1	Description of Baseline Situation and Energy Consumption	67
4.12.2	Suggested Measure of Improvement	67
4.12.3	Potential Energy Savings and Greenhouse Gas Emission Reduction	69
4.13	Biogas from Sewage Plant	70
4.13.1	Description of Baseline Situation and Energy Consumption	70
4.13.2	Suggested Measure of Improvement	70
4.13.3	Potential Energy Savings and Greenhouse Gas Emission Reduction	72
4.14	Combined Heat and Power Production	73
4.14.1	Description of Baseline Situation and Energy Consumption	73
4.14.2	Suggested Measure of Improvement	73
4.14.3	Potential Energy Savings and Greenhouse Gas Emission Reduction	74
4.15	Outlook on Further Developments	77
4.15.1	Digital Twins	77
4.15.2	Biorefineries	78
◆ 5	Conclusions	80
◆ 6	Literature	84

List of Figures

Figure 1: TFC Shares	15
Figure 2: TFC Shares / Industry	16
Figure 3: ODEX Indicator- Industrial Sectors European Union	17
Figure 4: ODEX Indicator- Industrial Sectors Germany	17
Figure 5: Illustration of process flow in pulp and paper manufacturing operations	21
Figure 6: Overview of the main processes of a kraft pulp mill	22
Figure 7: Digester	24
Figure 8: Preparation of Deinked (Recycling) Paper (UPM , 2020)- translated from German	24
Figure 9: Example of plant concept for newsprint	25
Figure 10: Paper Machine (adapted from ANDRITZ)	26
Figure 11: Paper Production Figures in Europe	27
Figure 12: Unit Consumption toe/t paper in Europe	28
Figure 13: Unit Consumption toe/t paper of selected European countries	28
Figure 14: Energy and material flows	30
Figure 15: Relevance of process steps for energy consumption	31
Figure 16: Simplified batch digester system	34
Figure 17: Illustration of Cold-Blow Technology	36
Figure 18: Illustration of a pulp manufacturing process – Rotary kiln	37
Figure 19: Left: Exterior of a lime re-burning kiln, Right: Interior of a lime re-burning kiln	37
Figure 20: A flame profile in a kiln with and without oxygen enrichment	38
Figure 21: Rotary kiln refractory systems	39
Figure 22: Illustration of example of a pulp manufacturing process – Evaporator	41
Figure 23: Schematic view of a refiner	43
Figure 24: Paper machine structure – Dryer section	45
Figure 25: Schematic of the paper dryer section of a paper machine	46
Figure 26: Schematic of a thermo-compressor	47
Figure 27: Hood air system, dryer section	48
Figure 28: Paper machine structure – Press section	50
Figure 29: Left: Illustration of the conventional –press technique, Right: Press nip in tissue paper machine	51
Figure 30: Rebuild from conventional to shoe press	51

Figure 31: Illustration of the difference between conventional (roll) press and shoe press curves. The areas under the curves are the press impuls (1 psi = 6.9 kN/m²) 52

Figure 32: Paper machine structure – dryer section 54

Figure 33: Four (4) main stages of condensate behavior in drying cylinders 55

Figure 34: Main types of siphons in drying cylinders, a rotary (left) or stationary (right) siphon removes condensate from the inside surface of the dryer cylinder shell. 55

Figure 35: Dryer cylinder and stationary siphon, Left: without turbulator bar – Right: with turbulator bar 56

Figure 36: Removeable insulating pads 58

Figure 37: Control of pump flow by using a throttle valve 62

Figure 38: Comparison of fixed speed and VFD pump power curves 63

Figure 39: Waste incineration process steps 67

Figure 40: Flow diagram of incineration plant 68

Figure 41: Illustration of wastewater treatment sites and nomenclature of pulp and paper mill sludge 70

Figure 42: Illustration of wastewater treatment sites and AD at a pulp and paper mill 71

Figure 43: EffiSludge concept 72

Figure 44: Diagram comparing losses from conventional generation vs. Cogeneration 73

Figure 45: Example of a CHP plant at a pulp/paper mill 74

Figure 46: Dryer cylinder and stationary syphon Source: (Arumugam, 2015) 78

List of Tables

Table 1: Overview Measures	12
Table 2: Energy and CO ₂ Savings Overview	13
Table 3: Draft Product Benchmarks	29
Table 4: Pulp and paper energy efficiency measures	33
Table 5: Key facts of measure – Batch Digester Improvement	56
Table 6: Key facts of measure – Lime Kiln Modification, Oxygen Enrichment	40
Table 7: Key facts of measure – Lime Kiln Modification, High-Performance Refractory	40
Table 8: Key facts of measure – Black liquor evaporator	42
Table 9: Typical power consumption in refining by product	43
Table 10: Cost calculation for a refiner (300 bone dry tonnes/day) for hardwood refining	44
Table 11: Key facts of measure – High Efficiency Refiner	44
Table 12: Example of heat recovery and heat losses of a paper machine with a production of 667 t/d	46
Table 13: Key facts of measure – Waste heat recovery, Radial blowers	49
Table 14: Key facts of measure – Waste heat recovery, Thermo-Compressors	49
Table 15: Key facts of measure – Waste heat recovery, Paper machine hood	49
Table 16: Key facts of measure – Shoe Press	53
Table 17: Key facts of measure – Stationary siphon and drying bar	56
Table 18: Available types of steam trap and its features	57
Table 19: Key facts of measure – Steam traps maintenance	59
Table 20: Control systems and typical energy efficiency improvement potentials	61
Table 21: Key facts of measure – Real-Time energy management system	61
Table 22: Key facts of measure – Energy-Efficient Frequency Inverter for pumps, fans, and compressors	64
Table 23: Key facts of measure – Drying of biofuel and sludge with utilizing excess heat	66
Table 24: Key facts of measure – Waste incineration plant	69
Table 25: Key facts of measure – Biogas from sewage plant	72
Table 26: Comparison of the environmental performance of a combined cycle gas turbine plant and a public utility supply in Germany	75
Table 27: Capital investments required in 2010 according to size and technology	76
Table 28: Key facts of measure – Combined heat and power production	76
Table 29: Overview Key Facts	81

Abbreviations

AD	Anaerobic Digestion
ASP	Activated Sludge Process
ASTEPP	Advanced Sensing Technologies for Paper Production
BAT	Best available technology
BLGCC	Black Liquor Gasification Combined Cycle
BREF	Best Available Technologies Reference Documents
CBG	Compressed Biogas
CCGT	Combined Cycle Gas Turbine
CHP	Combined Heat and Power
CMP	Chemimechanical pulp
CNCG	Concentrated Non-Condensable Gas
CO₂-eq	Carbon dioxide Equivalent
COD	Chemical Oxygen Demand
CTMP	Chemithermomechanical pulp
DIP	Deinked paper
DME	Dimethyl Ether
DS	Dry Solid
EEA	European Environment Agency
EFB	Empty Fruit Bunches
ETS	Emissions Trading System
EU	European union
GHG	Greenhouse Gas
GJ	Gigajoule
GJ/ADt	Gigajoule per air dry tonne
GT	Gas Turbine
GW	Groundwood
HRSG	Heart Recovery Steam Generator
IC	Internal Circulation
IEA	International Energy Agency
IGES	Institute for Global Environmental Strategies
IPI	Industrial Production Index
ISO	International Standards Organization
JRC	Joint Research Centre
kWh	Kilowatt hour

kWh/ADt	Kilowatt hour per air dry ton
kWh/kg	Kilowatt hour per kilogram
LBG	Liquefied Biogas
LP	Low Pressure
mm	Millimetre
MP	Medium Pressure
Mt	Million tonne
MW	Megawatt
MWh	Megawatt hour
NCASI	National Council for Air and Stream Improvement
NGO	Non-Governmental Organization
O&M	Operation and Maintenance
ODEX	Objective of the Energy Efficiency Index
PGW	Pressure Groundwood
RAS	Return Activated Sludge
RCF	Recovered fibre
RMP	Refiner mechanical pulp
SCOD	Soluble Chemical Oxygen Demand
t/d	Tonne per day
t/h	Tonne per hour
t/yr	Tonne per year
TFC	Total Final Consumption
TMP	Thermomechanical pulp
UASB	Up-flow Anaerobic Sludge Blanket
UNEP	United Nations Environment Programme
VFD	Variable Frequency Drive
WAS	Waste Activated Sludge
WWT	Wastewater Treatment



1

Executive Summary

Energy efficiency improvements in the industrial sector are a powerful and efficient means to reduce overall energy consumption and greenhouse gas emissions given the following facts:

- **Large shares of TFC** (total final energy consumption) **attributable to the industrial sector**, corresponding to 28.6 % (world average) and even 48.3 % (China) (IEA, 2018)
- Prevailing large shares of **fossil fuel in industrial energy consumption** (TCF)– both worldwide (10 % oil products, 20 % natural gas, almost 30 % coal) and in China (roughly 5 % oil products, 7 % natural gas, 50 % coal) (IEA, 2018)
- Considerable leverage effect due **to relatively few actors** in the industrial sector (large energy savings can be achieved by one single industrial company, in contrast to measures targeting other sectors)
- Current potential of considerably high levels of **untapped energy efficiency** and
- **Additional benefits:** increased competitiveness, smooth production – less down time, positive impacts on resource efficiency covering all media: water, air, soil and materials.

In Europe, the most successful set of measures for energy efficiency improvement comprises the application of benchmark values, both for the permission of new installations (see also Best Available Technologies as referred to in the **BAT documents**), and the determination of reference values for the share of free allocation in the **European Emission Trading Scheme**. The EU ETS is a cap and trade system in place since 2005. It currently covers about 11,000 heavy energy users including power stations, industrial plants and airlines, together responsible for about 40 % of overall carbon emissions in the participating countries. Preliminary results show that so far, the scheme has significantly contributed to overall emission reductions and led to reductions by approximately 35 % in the period 2005 – 2019. Further efforts are required to reach the overall goal of GHG reduction by at least 55 % by 2030, as defined in the European Green Deal. Another important policy instrument which leads to continuous improvement of (industrial) processes is the obligation of large enterprises to perform external energy audits

all four years or alternatively implement an energy or environmental management system following the requirements of the **Energy Efficiency Directive** (Directive 202/27/EU and its amendment in 2018).

Energy efficiency measures range from “simple” good housekeeping and the use of control systems (both of which are prerequisites for the following measures) to changes of equipment, process integration and application of alternative processes. The following guideline focuses on process-related measures for the **pulp and paper industry**. The selection of these measures is based on their achievable potential/applicability (with focus on China) as well as their effectiveness (necessary changes/ investment costs in comparison to achievable benefit). Data sources are not only international and local studies/analysis but also estimations based on experts’ experiences.

Unit energy consumption per tonne of paper product in Europe ranges from 1.5 MWh to 6.6 MWh, which still shows considerable room for improvement at individual mill level. However, the overall average figure has remained almost stable in the last years, amounting to about 3 MWh/t_{paper}. Processing steps addressed in this guideline comprise both the pulping process and the paper production along with relevant energy supply options. Pulping produces either virgin pulp (either via mechanical or chemical pulping) or recycled pulp from wastepaper (including additional processes in the pulper, screens, deinking and -if required - bleaching). The actual papermaking process covers the stages of the headbox, sieve, wires, dryers and further steps such as calenders depending on the type of paper produced.

The sub-processes with the **highest relevance for energy consumption** are:

- Pressing and drying
- Refining and grinding for non-recycling paper
- Screening and deinking for RCF based paper/tissue

The following energy efficiency measures were identified as the most promising ones and are described in detail in this guideline.

Overview Measures

Chapter	Measure	Process	
4.1	Batch Digester Improvement	Chemical Pulping	
4.2	Lime Kiln Modification	Oxygen Enrichment	Chemical Recovery
		High-Performance Refractory	Chemical Recovery
4.3	Black liquor Evaporator	Chemical Recovery	
4.4	High Efficiency Refiner	Mechanical Pulping	
4.5	Waste Heat recovery	Radial blowers	Paper Making
		Thermo-Compressors	Paper Making
		Paper Machine Hood	Paper Making
4.6	Shoe Press	Paper Making	
4.7	Stationary Siphon and Drying Bar	Paper Making	
4.8	Steam Traps Maintenance	Steam System	
4.9	Real-Time Energy Management System	All processes	
4.10	Energy-Efficient Frequency Inverter for Pumps, Fans, and Compressors	All processes	
4.11	Drying of Biofuel and Sludge with Utilizing Excess Heat	Chemical Recovery	
4.12	Waste Incineration Plant	Chemical Recovery	
4.13	Biogas from Sewage Plant	Chemical Recovery	
4.14	Combined Heat and Power Production	Chemical Recovery	

According to practical experience, especially the following measures provide for energy savings in almost all paper mills: **improvement of refiners and paper machine hoods**. Additionally, shoe presses and variable frequency drives (VFD) should be implemented in mills where they are currently not in use. For integrated paper mills, batch digester improvement, lime kiln oxygen enrichment and high performance refractory

as well as black liquor evaporators should be considered.

The actual investment costs and savings depend on the current type and energy-consuming status of the respective mill, but in light of respective literature and own experiences, the following efficiency potentials are identified:

Energy and CO₂ Savings Overview

Chapter	Measure	Energy Savings				CO ₂ mitigation	
		Thermal	Electrical	Value (rounded)	Unit	Value	Unit
4.1	Batch Digester Improvement	×	×	350	kWh/t pulp	137	kg CO ₂ /t pulp
4.2	Lime Kiln Oxygen Enrichment	×	×	30	kWh/t pulp	13	kg CO ₂ /t pulp
	Lime Kiln High Performance Refractory	×	×	20	kWh/t pulp	7	kg CO ₂ /t pulp
4.3	Black liquor Evaporator	×	-	60	kWh/t black liquor	23	kg CO ₂ /t black liquor
4.4	Refiner Improvement	-	×	20	kWh/t paper	12	kg CO ₂ /t paper
4.5	Radial Blower	×	-	30	kWh/t paper	12	kg CO ₂ /t paper
	Thermo Compressor	×	-	25	kWh/t paper	10	kg CO ₂ /t paper
	Paper Machine Hood	×	-	200	kWh/t paper	78	kg CO ₂ /t paper
4.6	Shoe Press	×	-	180	kWh/t paper	70	kg CO ₂ /t paper
4.7	Stationary Syphon and Drying Bar	×	-	250	kWh/t paper	98	kg CO ₂ /t paper
4.8	Steam Traps Maintenance	×	-	500	kWh/t paper	195	kg CO ₂ /t paper
4.9	Energy Management System	×	×	110	kWh/t paper	43	kg CO ₂ /t paper
4.10	Energy Efficient Frequency Inverter for Pumps, Fans and Compressors	-	×	10	kWh/t paper	6	kg CO ₂ /t paper
4.11	Drying of biofuel and Sludge with utilizing excess heat	×	-	no quantification possible per ton product**			
4.12	Waste incineration plant	×	-				
4.13	Biogas from sewage plant	×	(×)*				
4.14	Combined heat and power production	×	(×)*				

*production of electricity

** The measures relate to optimization of energy supply (for the pulp and paper mills) and due to different types of mills and energy supply baselines, there is no uniform way to express the savings per tonne of product

For the measures:

- Drying of biofuel and sludge with utilizing excess heat
- Waste incineration plant
- Biogas from sewage plant
- Combined heat and power production

the achievable savings, in terms of energy and CO₂, depend on the specific plant and applications; determining factors are presented in the respective sub-chapters. Further energy (and resource) saving potentials which go beyond currently applied energy saving measures can be realized by implementing digital twins for optimization of the plant concept, design and operation. Another option is to extend the scope of products provided by a mill to a biorefinery producing also chemicals, materials, electricity and biofuels.



2

Introduction on Energy Efficiency in Industry

2.1 Energy Consumption and Status of Energy Efficiency

Industry is one of the **major energy consuming sectors** worldwide and in China, as shown in the following

charts depicting the Total Final Consumption (=TFC) shares:

TFC Shares

Share of TFC, European Union 28 (2018)

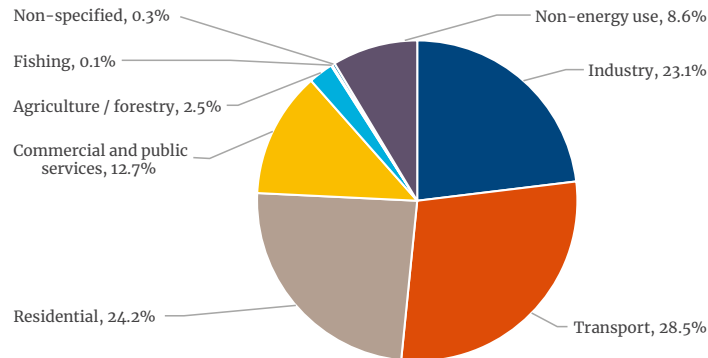

Share of TFC, World (2018)

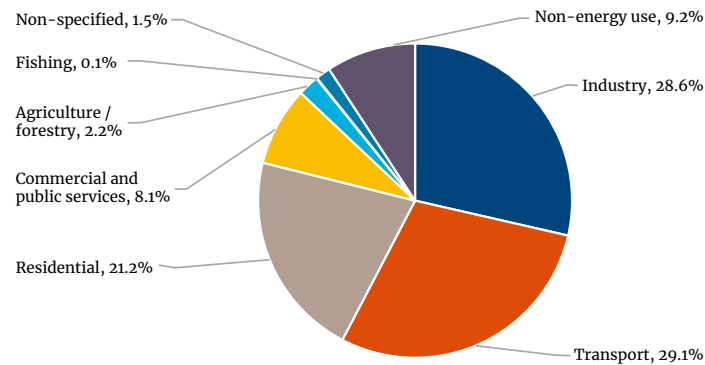

Share of TFC, World (2018)

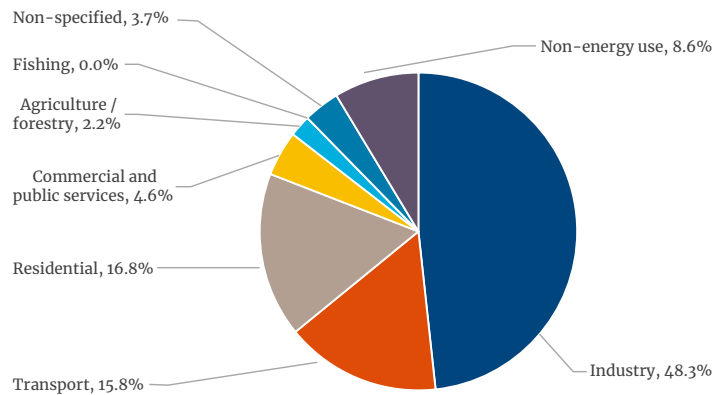

Source: (IEA, 2018)

Relating to energy sources used in industry, the relative importance of energy sources differs considerably

among different countries – especially with respect to coal and natural gas.

TFC Shares / Industry

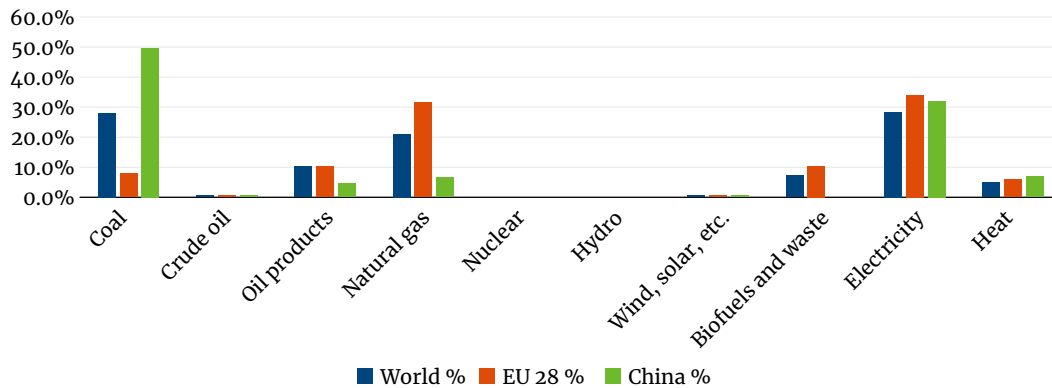

Source: (IEA, 2018)

Energy efficiency in industry is considered as one of the most powerful measures to reduce overall energy consumption and GHG –due to not only the size/ importance of the industrial sector but also because there are relatively few actors in comparison to others sectors. Thus, efficiency changes in one plant lead to comparatively large savings.

In the European Union, industrial energy consumption has been decreasing considerably since 2007. However, more than half of the reduction was due to a decrease in the overall industrial activity as a result of the recession. **Energy efficiency has still improved in the last years** (at rates at about 1 % per year), but still at a

lower level than in the early 2000s. This can be partly explained by large equipment not operating at full capacity – and thus less efficiently – and also by the fact that part of energy consumption is more or less fixed and not related to production levels. (Fraunhofer ISI, 2018)

Overall energy efficiency progress can be measured via different indicators. One of them is the ODEX indicator¹ which measures energy consumption (physical, not financial) against production activity at sector level. This indicator is used for the industrial sector in the European Union and shown in the following graph.

¹ “ODEX” (objective of the energy efficiency index) is derived at sector level (household, industry, transport) and weighs the indices of specific consumption by sub-sector (or end-use) with the share of each sub-sector in the sector’s energy consumption. In the industry sector ODEX is derived at the level of 14 branches based on specific consumption per tonne for steel, cement and paper and consumption per IPI (industrial production index) for other branches.

ODEX Indicator- Industrial Sectors European Union

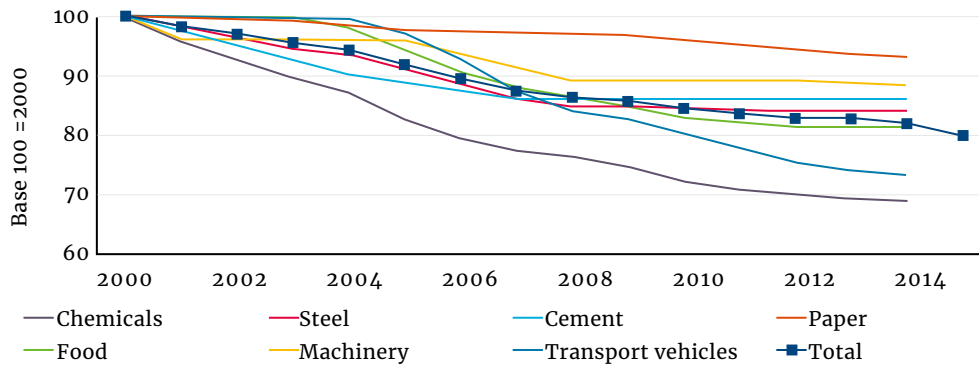

Source: Bruno Lapillonne, 2018

It is clear that the overall energy efficiency has been improving by about 1.4 %/year since 2000 (or by 17 % cumulatively since 2000). However, the rate of im-

provement slowed down since the economic crisis. In Germany, for example, this effect is more noticeable:

ODEX Indicator- Industrial Sectors Germany

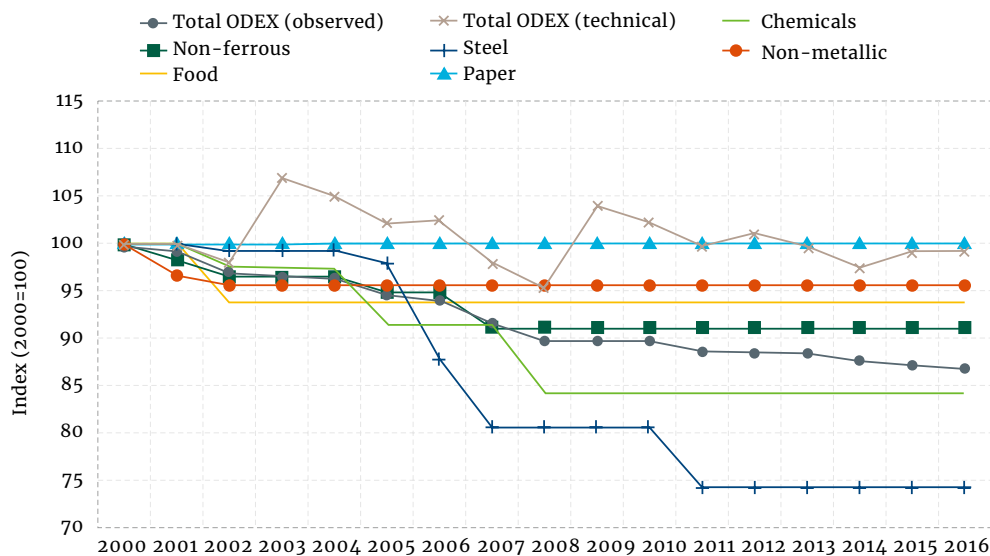

Source: (Fraunhofer ISI, 2018)

There are several studies referring to **considerable potential of energy efficiency currently available worldwide**. E.g., a study from IEA (2007) cited in the UNEP Best Practices and Case Studies Analysis (Fawkes, 2016) shows an overall potential summing up to 600 - 900 Mtoe/year and 1,900 - 3,200 Mt CO₂ savings per year based on commercial, cost-effective proven tech-

nologies. These figures correspond to global improvement potentials around 18 - 26 % of global industrial energy uses and 19 - 32 % of global CO₂ emissions in the industrial sector. The highest potentials are expected to be in the chemicals, iron and steel, cement and pulp and paper sectors.

2.2 Energy Efficiency Policy and Management

In general, policy options can be categorized as “**carrots**” (incentives which make the desired action, in this case increasing energy efficiency, more attractive) and “**sticks**” (penalties for companies not complying with relevant targets) and these policy options can take the form of regulatory measures, fiscal/financial policies and information/capacity building (Fawkes, 2016). In the industrial sector in Europe, the most important tools and measures comprise definition of benchmarks (Best Available Technologies), the European Emission Trading scheme and the obligation to apply energy auditing.

Considerably different energy consumption/energy efficiency figures can be observed in the same industry’s different production sites depending on the technologies applied, the size of the plant and its operation. One of the most powerful method of examining different production sites is to compare their actual consumption with sectoral energy benchmarks and – more globally – their respective distance to **Best Available Technologies (BAT)**.

In Europe, for example, there are reference documents describing Best Available Technologies, called BREFs, for industrial sub-sectors following the requirements of the EU Industrial Emission Directive². The results, which cover not only the energy consumption performance, but also the relevance for emissions to air, water and soil as well as regarding resource efficiency are derived from discussions between industry representatives, NGOs, the member states and the European Commission and are published on the website of the European IPPC Bureau under <https://eippcb.jrc.ec.europa.eu/reference>. According to these results, new installations have to comply with BAT standard and corresponding emission levels from the start of operation; existing installations have to be adapted within 4 years after publication of BAT conclusions.

Another application of benchmarking against the most efficient industrial plants can be found within the **European Union Emission Trading scheme** operating since 2005. This market-based mechanism aims to reduce overall GHG emission in the most cost-effective way and is designed as a cap-and-trade system. This means that a specific cap is defined for all covered installations (currently about 11,000 heavy energy-using installations including power stations & industrial plants and airlines operating between these countries) responsible for about 40 % of overall emissions of the participating countries³. This cap sets the total amount of greenhouse gases which can be emitted by all installations covered by the system. The “emission allowances” have to be surrendered each year by the companies to fully cover their actual emissions. Part of the allowances are allocated to the companies depending on a mechanism taking into account – among others – both historical emissions of the respective sector and emission levels of the best 10 % of participating companies (benchmarking). The difference (either surplus or lack) can be traded on the market.

Preliminary results show that the scheme reaches its targets and emissions of the **covered installations were reduced by about 35 % between 2005 and 2019**. In order to achieve a higher and more robust carbon price, the “Market Stability Reserve” was introduced 2019. Following the **European Green Deal**⁴, the EU’s overall greenhouse gas emission **reduction was set to 55 % by 2030**. Within this package, energy efficiency was the first to be identified as one of the key objectives because it was considered one of the easiest ways to reduce greenhouse gas emissions and reduce energy costs. Thus, the EU has set binding targets of at least **32.5 % increase in energy efficiency by 2030**, relative to a ‘business as usual’ scenario. Additionally, the new target for **renewable energy share** was set to at least **32 %** for 2030 (European Commission, 2018, last update 12/2020). In this regard, a revision and possible expansion of the EU-ETS is currently under discussion.

² Industrial Emissions Directive (IED, 2010/75/EU)

³ Countries of the European Union, Norway, Iceland

⁴ Following the 2015 Paris Climate Agreement, the European Union pledged to achieve greenhouse gas emission reductions of at least 40% by 2030 compared to 1990. With a view to this target and in order to pave the way towards energy transition the European Commission presented new, more ambitious rules in 2016, called the Clean Energy Package for all Europeans.

One of the generally important aspects of any saving project is the **application of monitoring and verification** which sets the basis of verifying the actually achieved savings. For those companies wishing to extend their knowledge basis and integrate energy management in their overall quality/environmental processes, the application of established management tools and processes in the Standard ISO 50001 can be an option.

2.3 Overview of Energy Efficiency Measures

Although reaching (theoretical) energy efficiency limits set by the rules of thermodynamics is not expected, there are limitations especially due to ongoing practice and cost constraints. The more the “low hanging fruits” are harvested, the more difficult it gets to identify further feasible energy saving potentials. In the “**energy maturity model**” (cited in: (Fawkes et al., 2016) it is differentiated between:

- **(good) housekeeping** (including maintenance, routine inspections, correct installation of all equipment, correct size of equipment according to actual demand, ensure proper insulation etc.)
- **Use of control systems** (covering e. g. temperature control limits, reducing excess flows, using variable speed drives, using preventive maintenance)
- **Simple modification** (change of equipment)
- **Process integration** (using heat exchangers, closed-loop systems or waste heat recovery) and
- **Alternative processes** (such as combined heat and power plants, applying dynamic simulation and predictive controls, or applying new process technologies)

The higher the energy maturity, the higher the potential savings are, but also the higher the efforts, knowledge, complexity and also business risks are. Thus, all saving projects should start with easy and low energy maturity aspects. Improving single cross-cutting technologies such as motors, variable speed drives and their optimization are important for several industri-

In Europe, large enterprises either have to apply such energy (or environmental) management systems or regularly conduct energy audits in all of the four years following the requirements of the **Energy Efficiency Directive** (Directive 2012/27/EU and its amendment in 2018).⁵

al sectors, but these are not within the scope of this guideline. The same applies to the need of considering the impact of the status of industrial enterprises’ buildings on the energy consumption. Process-related measures along the whole production processes (Fawkes, 2016), such as:

- The **optimization of steam systems** (minimize the number of heat transformations, preheating water or air, using energy efficient heat exchanger designs, minimizing/optimizing simultaneous heating and cooling)
- Optimization of **cooling and refrigeration**
- Recognizing the effects of **water chemistry** (mineral salts, dissolved gases etc.) on water quality/treatment requirements
- Installing **combined heat and power** instead of high-temperature heat losses
- Applying **heat recovery** both within one company or also to neighboring heat users or district heating systems
- Using **waste heat to power** for industrial processes with high waste heat temperatures
- Converting waste from production as an **energy source** (after screening options for re-use or recycling)

might be interesting options for various industries and are explained in the specific guidelines for the corresponding sectors, if applicable.

⁵ Directive (EU) 2018/2002 of the European Parliament and of the Council of 11 December 2018 amending Directive 2012/27/EU on energy efficiency (Text with EEA relevance.)



3

Overview of the Pulp and Paper Sector

The following chapter provides an introduction to overall production processes in the pulp and paper sector and their relevance to overall energy consumption as well as a statistical overview of production and energy consumption related figures in Europe.

tion as well as a statistical overview of production and energy consumption related figures in Europe.

3.1 Description of the Production Process and Process Steps

Paper is made of fibers with chemicals added to improve the properties and quality of the final product. The fibers, known as the pulp, are obtained by chemical or mechanical processes either from virgin wood, other biomass or from recovered fiber. The actual manufacturing process in a pulp or paper mill varies

depending on the raw materials used and the paper products produced. However, the basic principle of pulping and papermaking remains the same. The following figure shows a simplified pulp and paper production process. Sites which include both pulp and paper production are called integrated mills.

Illustration of process flow in pulp and paper manufacturing operations

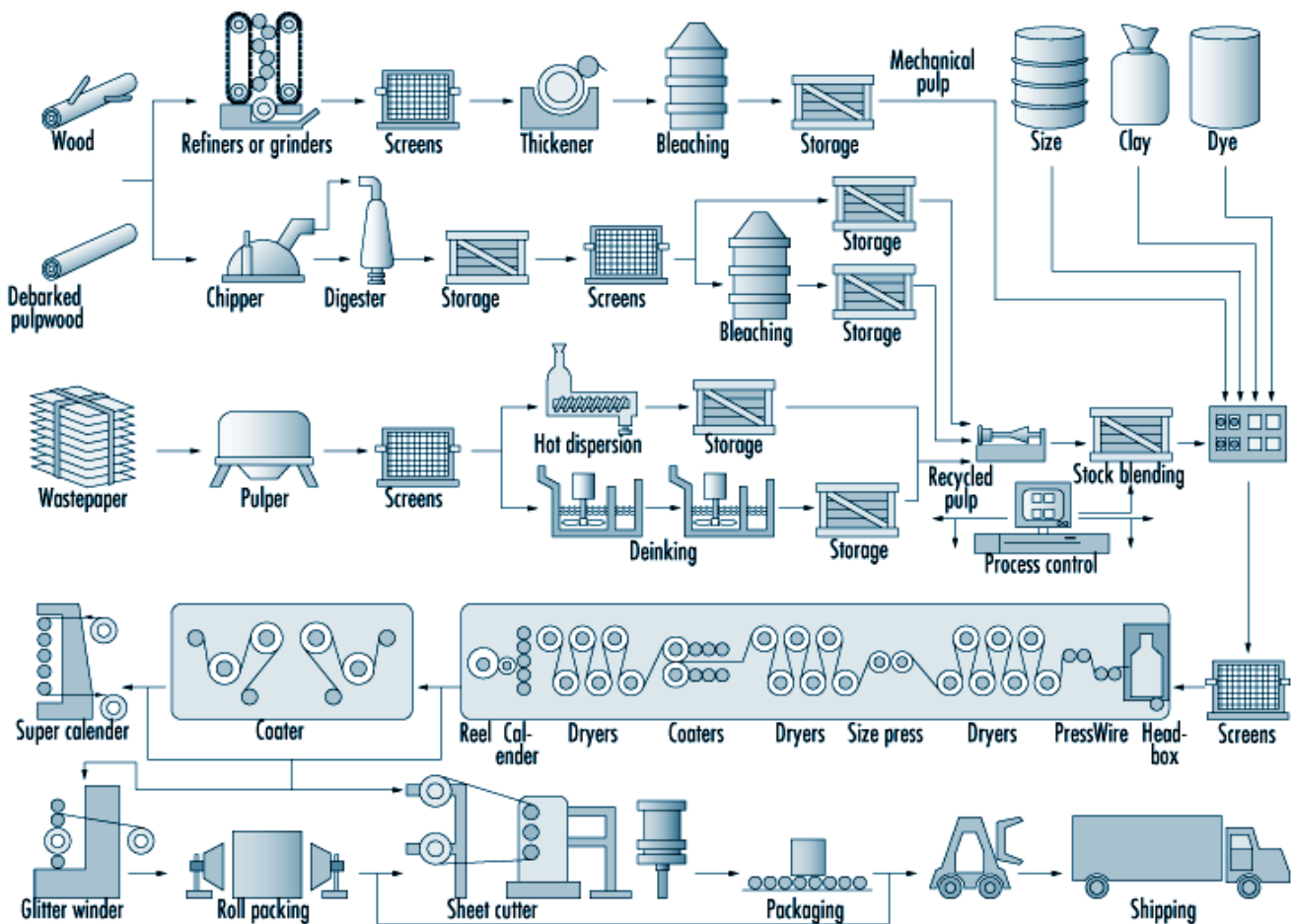

Source: Adapted from Weidenmüller 1984.

Source: (ILO Encyclopaedia

Paper is made through the following processes:

- Pulping procedure to separate and clean the fibers
- Refining procedure after pulping
- Dilution process to form a thin fiber mixture
- Formation of fibers on a thin screen
- Pressurization to reduce water content with mechanical energy
- Drying to reduce water content with thermal energy
- Finishing procedure to provide a suitable surface for usage.

In general, there are two main methods of separating fibers from wood or other biomass to produce pulp; one using chemicals and one using mechanical grinding. (Umwelt im Unterricht, 2018)

Chemical pulping

The following figure gives an overview of the main processes of a kraft pulp mill.

Overview of the main processes of a kraft pulp mill

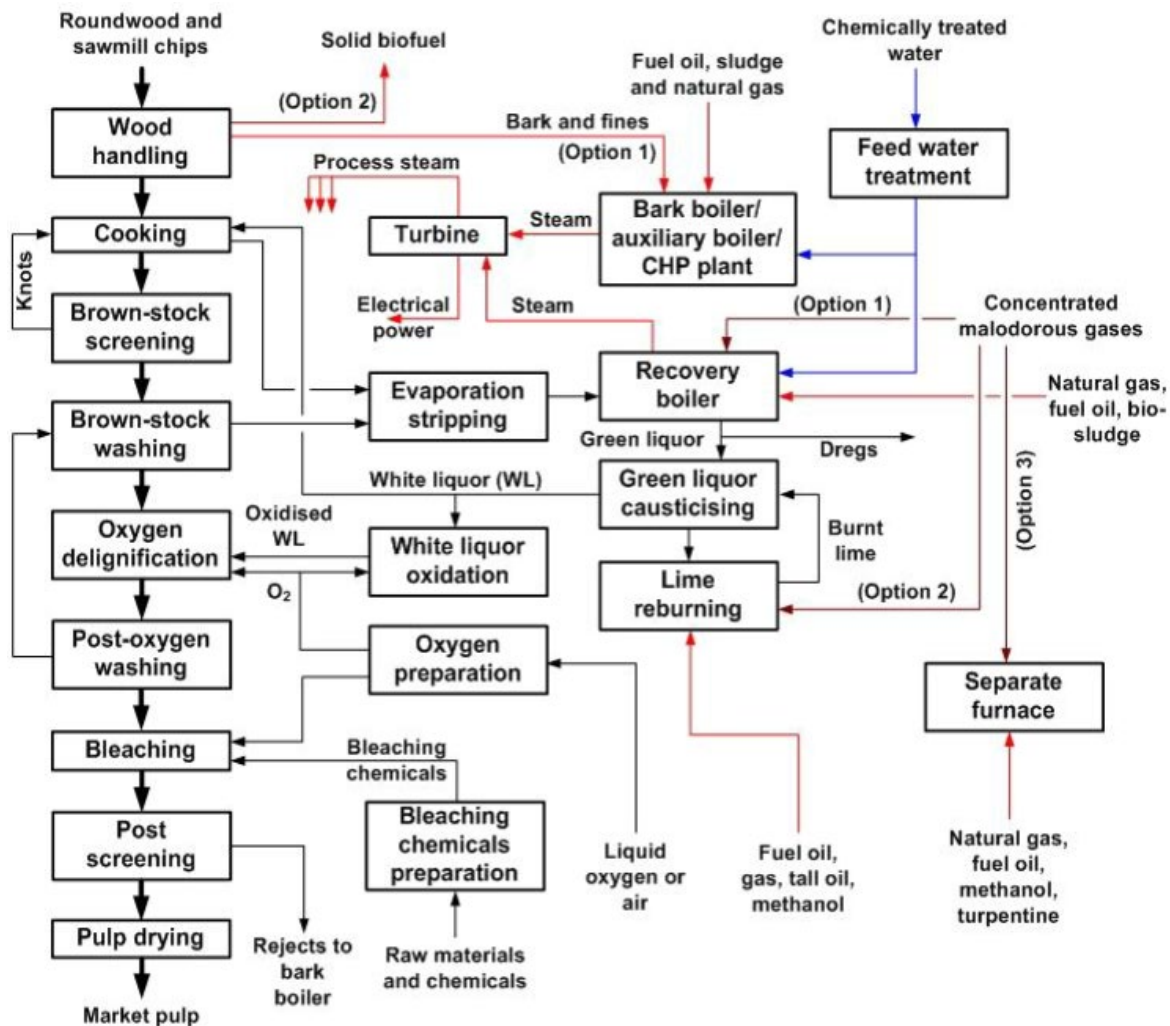

Source: (Suhr, et al., 2015)

For the production of pulp for fine and printing papers, two chemical processes are used: the sulfate and the sulfite process. The sulfate or kraft process, accounting for approximately 80% of the world pulp production, is the most commonly applied production method used in the chemical pulping processes. The importance of the sulfite process has steadily decreased and today only 10 % of world production is done by using this method. (Suhr, et al., 2015)

Kraft digestion is an alkaline digestion process in which the lignin is processed by NaOH and Na₂S. This process is suitable for all types of biomass and very effective. Disadvantages are the formation of odorous

mercaptans⁶ and sulfides, and the fact that the paper needs to be bleached more strongly than in the “sulfide process”. The process wastewater in the sulfate process contains SO₂ and has a pH value between 8 and 9. The resulting wastewater is not mixed with other process’ wastewater, but cleaned and neutralized separately.

The sulfite process is an acid digestion process which is more sensitive to knots and bark, as these are not digested in the sulfate digestion process. This process offers more variations for pulp production and is much less odorous. The strength of the paper is not as high as after the sulfate process. (Lenntech, kein Datum)

Mechanical Pulping

The defibration of the wood or other biomass in this method is done by mechanical means. The aim is to maintain the main part of the lignin to achieve a high

yield with acceptable strength properties and brightness. There are different procedures and techniques for mechanical pulping (Suhr, et al., 2015).

Pulping process	Raw materials	Typical end uses
Groundwood Pulp (GW) Pressure Groundwood (PGW)	Spruce and fir (softwood)	Printing & writing papers and newsprint
Thermomechanical pulp (TMP)	Spruce and fir (softwood)	Printing & writing papers and newsprint
Chemimechanical Pulp (CMP)	Spruce, but also aspen and beech, NaOH, Na ₂ SO ₃ , and H ₂ O ₂	Printing & writing papers, tissue, and packaging boards
Chemithermomechanical Pulp (CTMP)	Spruce, but also aspen and beech, NaOH, Na ₂ SO ₃ , and H ₂ O ₂	Printing & writing papers, tissue, and packaging boards

In GW pulping or PGW pulping, logs are pressed against a rotating grinder stone with the simultaneous addition of water. Refiner mechanical pulps (RMP), like those from TMP and CTMP, are produced by defibrating wood chips or other biomass between metal refiner discs.

The resulting lignin content in a continuing digester depends on the used wood or other biomass, chemical charge and retention time, as well as the temperature

in the cooking zone. In this process, as in the batch digester, the wood chips are preheated before entering the cooking zone. The chips (or other biomass) impregnation with cooking liquor, however, takes place in an impregnator tank, instead of in the main digester. After the impregnation, the temperature is raised to 155 – 175 °C. The cooking time at the maximum temperature is in the range of 1 – 2 hours (Suhr, et al., 2015).

⁶ Mercaptance is an organic gas composed of carbon, hydrogen, and sulfur.

Digester (Suhr, et al., 2015)

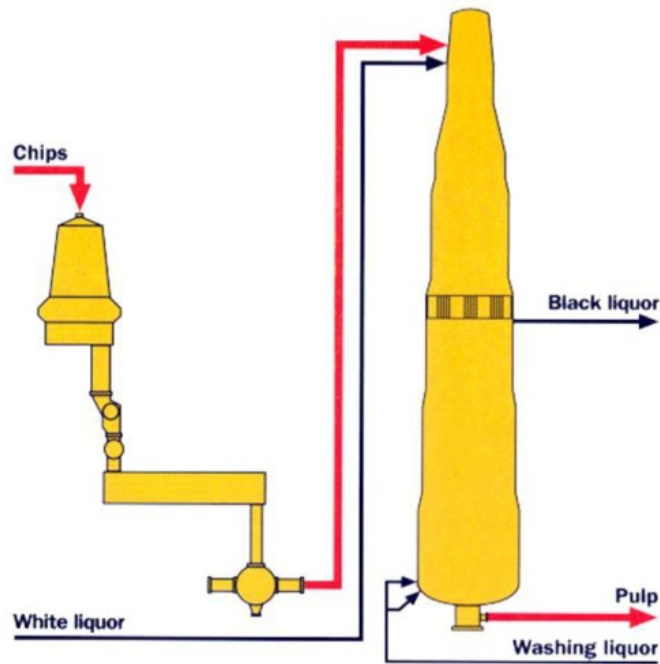

Paper making from recycling material

Paper making based on recovered fibre (RCF)/ recycling material requires additional process steps necessary for defibration, deflaking and removing of impurities. Specific process steps also depend on the final product e.g. newsprint, tissue paper or cardboard.

Depending on the final product, the only mechanical cleaning (e.g. testliners or boards) or additional deinking, e.g. for products like newsprint, tissue or board marked “DIP” (deinked paper), is applied.

Preparation of Deinked (Recycling) Paper (UPM , 2020)- translated from German

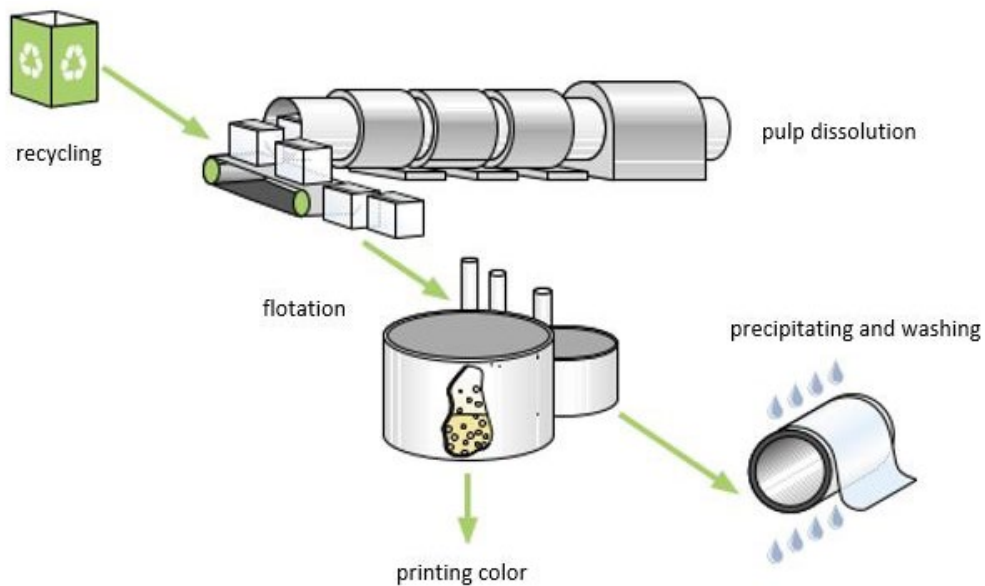

Major process steps are:

- Repulping of the dry paper for recycling: blending paper for recycling with hot water, white water or process water in a pulper for disintegration of fibres; processes for deinking require pulping additives (NaOH)
- Mechanical removal of impurities
- Flotation deinking (optional): releasing ink particles from fibres and keeping them in dispersion via adding NaOH and sodium silicate; separate fibres from ink via (multi-stage) flotation techniques; thickening the pulp, sometimes washed in sieve belt presses, (disc) thickeners, screw presses and washers

- Further deinking of smaller particles via wash deinking and ash removal (optional)
- Bleaching (optional)

Each tonne of recycled paper leads to about 100 - 150 kg de-inking residue, which is mostly further used for energy purposes (burning of reject). (UPM , 2020)

The following flowchart shows an example of process steps necessary for processing paper for recycling for newsprint as shown in the BAT document.

Example of plant concept for newsprint

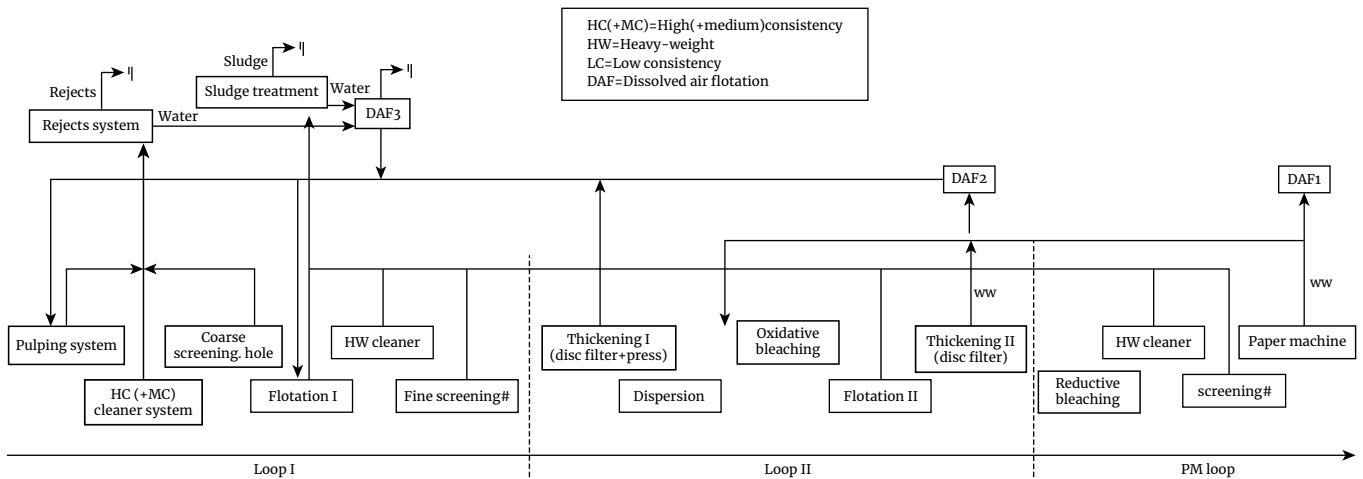

Source: (Suhr, et al., 2015)

After stock preparation (refining), which is the process that adapts raw stock (chemical pulp, mechanical pulp, recycled paper – as described above) into fin-

ished stock ready for the production of paper, the actual paper production process starts.

Refining

Refining is the process to adapt the fibres to the desired properties of the final product and takes place in refiners with rotating or rotating and stationary disks. The electrical energy consumption of the refining process is normally in the range of 10 kWh/t to 500 kW/t,

but can reach up to 3,000 kWh/t for speciality papers (Suhr, et al., 2015). Hence, for a non-integrated paper mill using chemical pulp, the process of refining is the largest electricity consumer.

Paper production:

Paper production itself is done within large paper machines which consist of the following sections:

- Headbox: supplies the fibre suspension – water content after this section: 99 %
- Sieve: fibres are dispersed uniformly on the sieves, this section determines the alignment of the fibres and strength of the paper, most of the water is removed – water content after this section: 80 %
- Press: further water is removed via presses; specific volume, opacity and fiber bond are controlled in this section – water content after this section 50 %
- Dryer section: further drying via steam-heated hollow cylinders – water content after this section 3 - 8 %
- Calender (makes the paper smooth and glossy), Rolls and Winder: form the paper to machine rolls. ((UPM , 2020).

The following chart shows the different sections of a paper machine:

Paper Machine (adapted from ANDRITZ)

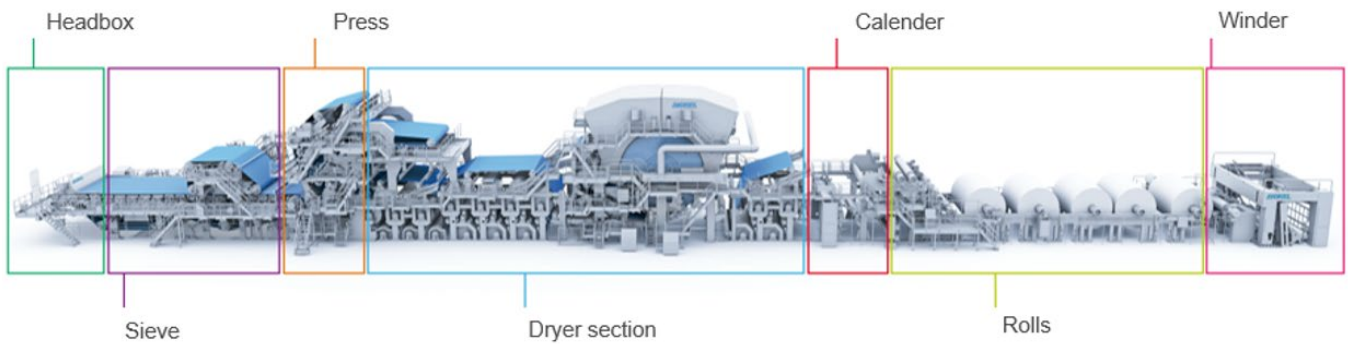

3.2 Current Situation and Development of Energy Efficiency in the Sector

This chapter analyses the current situation of energy consumption and energy efficiency of the pulp and paper sector in Europe and provides an overview of the

major energy consuming processes relevant for this sector.

3.2.1 Energy Statistics and Benchmarks Pulp & Paper

Below chart provides an overview of paper production in European countries. The aggregated amount of paper production in the European Union was 92,538.2 kt

in the year 2018. The largest four production countries (Germany, Finland, Sweden, Italy) covered 56% of overall production.

Paper Production Figures in Europe

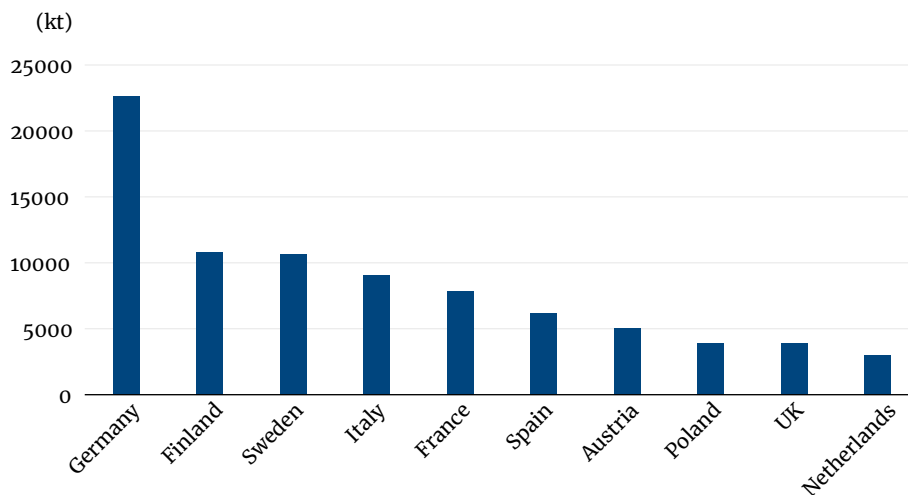

Source: (ODYSSEE Database, 2018)

With regards to analyzing energy consumption of specific sectors, it is prevalent that the unit energy consumption is defined as the energy input necessary for the production of one unit of output and in the case of pulp and paper production this figure relates to one

tonne paper/pulp produced. **Unit Energy Consumption** in toe/t paper ranged from 0.13 toe/t (Switzerland) to 0.57 toe/t (Slovakia), the European Union average in 2018 corresponded to 0.26 toe/t (**approximately 3 MWh/ton**).

Unit Consumption toe/t paper in Europe (2018)

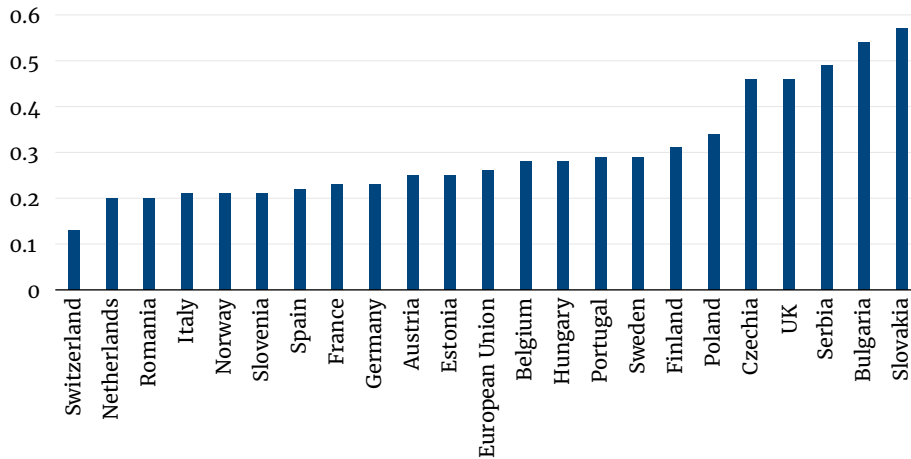

Source: (ODYSSEE Database, 2018)

As for the unit consumption, the development of overall unit consumption on average remained almost stable on European level.

Unit Consumption toe/t paper of selected European countries

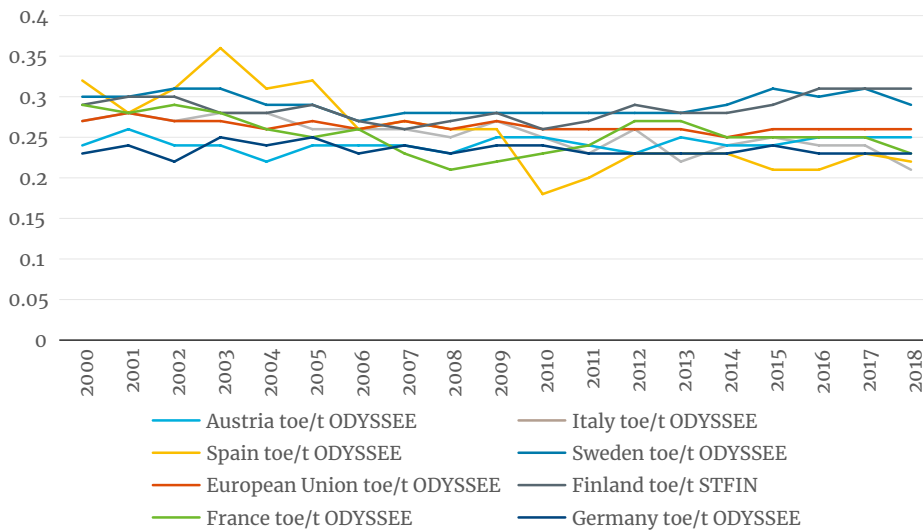

Source: own chart based on data from (ODYSSEE Database, 2018)

However, there still is room for improvement at single mills, not only in terms of **(final) energy savings**, but also in terms of reduction of **Greenhouse Gas Emissions** – either via energy efficiency measures reducing final energy consumption, or fuel switch/production changes “only” leading to primary energy savings and GHG reduction. The following table shows the current levels of some of the pulp & paper product benchmarks

in the EU ETS (European Commission, 2021), which are defined in tonnes CO₂ per tonne of product. Additionally, the table shows the average value of the 10 % most efficient installations⁷. Comparing most efficient installations and benchmark values we can note further room for reducing CO₂ emissions related to paper production.

Draft Product Benchmarks

Product benchmark	Average value of the 10% most efficient installations in 2016 and 2017 (t CO ₂ equivalents/t)	Benchmark value (allowances/t) for 2021-2025
Sulphite pulp,thermo-mechanical and mechanical pulp	0,000	0,015
Recovered paper pulp	0,000	0,030
Newsprint	0,007	0,226
Uncoated fine paper	0,011	0,242
Coated fine paper	0,045	0,242
Tissue	0,139	0,254
Testliner and fluting	0,059	0,188
Uncoated carton board	0,009	0,180
Coated carton board	0,011	0,207

Source: (European Commission, 2021)

⁷ Due to use of biomass and waste for energy purposes the value can also be zero.

3.2.2 Energy Flows

The pulp and paper industry is highly energy intensive, consuming energy in the form of power as well as fuels. Due to shortages in energy availability and increase in energy cost, energy conservation has become a necessity in the paper industry. Sector-specific energy saving measures presented in the following chapters focus on the pulp and paper making process (while not considering crosscutting technologies such as efficient motors), along with the energy supply relevant for this sector.

The pulp and paper industry uses two types of end use energy: heat and electricity. Electrical energy is primarily used to drive pumps and fans. Thermal energy, in the form of steam, is used, for example, in digesters, in evaporators, and in the drying of pulp.

High-pressure steam is used to generate electrical power in turbo generators. Steam extracted from the turbine as medium- or low-pressure steam is mainly used for the following purposes:

- Heating water, wood chips, pulp fibres, air and chemicals to process temperature;
- Heating the cooking liquor in chemical pulping;
- Evaporating water from spent kraft and sulphite pulping liquors in the evaporators before firing the liquor in the recovery boilers;
- Dispersion in paper for recycling stock preparation (heating of the stock in dispergers in some cases);
- Evaporating water from the pulp or paper sheet in the dryer section of the paper or pulp machine;
- Drying of coated paper (Suhr, et al., 2015).

Energy and material flows

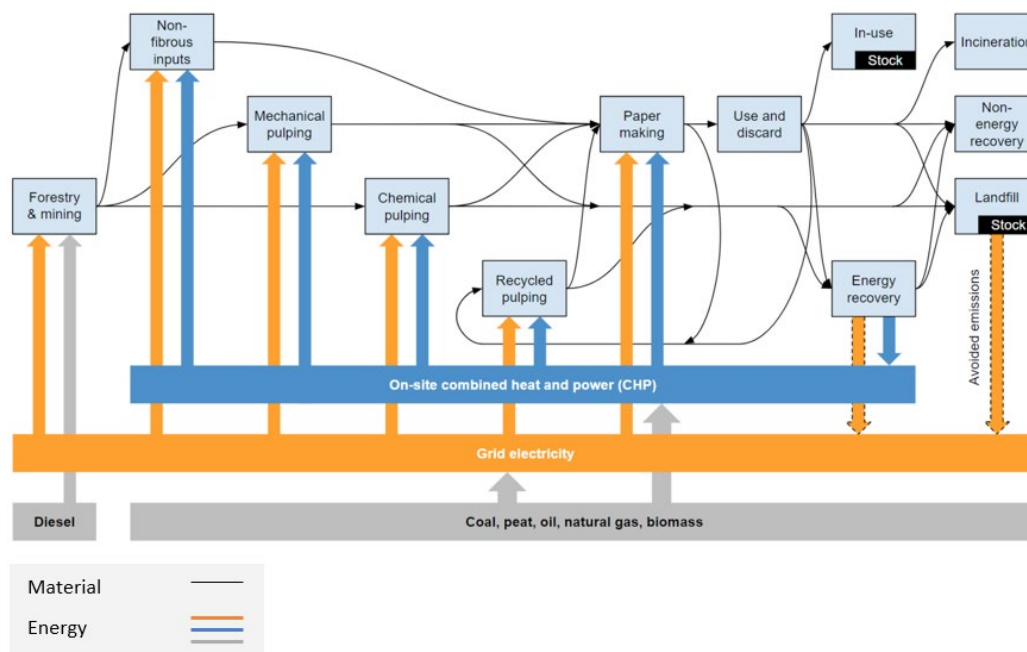

Source: (Ewijk, Stegemann, & Ekins, 2021)

Electric power is used for many purposes in pulp and paper mills such as:

- Grinders and refiners for the production of ground-wood pulp, TMP and CTMP;
- Pulpers to slush purchased pulp or in recycled fibre pulping;
- Pulp beating and pulp refining;

- Drives for paper machines and other pulp and paper machinery;
- Transports with pumps, fans, belt and screw conveyors;
- Mixing of fluids and suspensions;
- Chemical preparation on site;
- Vacuum pumps;
- Compressors.

3.2.3 Energy Intensive Processes

When analysing specific energy saving potentials and measures, one of the first steps is to identify major energy consuming processes in the respective sector. In this regard, a detailed analysis has been presented in the BAT document for pulp and paper which cites work performed by the German Federal Environmental Agency in 2009 (Blum et al., 2009).

As shown in Figure 15, it is very obvious that the most energy-intensive-process-steps in almost all types of paper production relate to the pressing and drying sections of the paper mill. Moreover, the processes of refining and grinding in pulp production (except for recycling paper/ RCF) are remarkably important energy consumers. Note: The higher the energy consumption, the darker the cell colour.

Relevance of process steps for energy consumption

process (1)	Integrated uncoated mechanical	Integrated coated mechanical	Non-Integrated uncoated wood-free	Non-Integrated coated wood-free	RCF without deinking	RCF-based graphic (with deinking)	RCF-based board (with deinking)	Non-Integrated tissue	RCF-based tissue	Specialty wood-free
Wood handling			NA	NA	NA	NA	NA	NA	NA	NA
Refining										
Grinding			NA	NA	NA	NA	NA	NA	NA	NA
Screening										
HC cleaning										
Thickening			NA	NA				NA		NA
Deinking			NA	NA	NA			NA		NA
Bleaching			NA	NA	NA			NA		NA
Mixing										
Approach flow										
Forming										
Pressing										
Drying										
Coating	NA		NA		NA	NA		NA	NA	
Calendering					NA		NA	NA	NA	
Finishing										
Central service										
	Very intensive (greatest consumer in the mill)									
	Considerable (major consumer)									
	Low (has only a minor impact on the energy situation of the mill)									
	Negligible									
NA	The process is not applied in the manufacturing of this grade									
	Varying because of differences in process and production within this grade									

Source: (Suhr, et al., 2015)



4

Sector Specific Energy Efficiency Measures



Table 4 presents the 14 energy efficiency measures analyzed in this chapter. Each chapter explains the baseline situation. The measure and its potential in energy and greenhouse gas emission reduction are clarified. In case energy savings and/or greenhouse gas emissions are not available from sources, own estimations

are made based on own experience, relevant energy consumption data in the pulp and paper industry (source: (Lingbo Kong, 2013)) and (average) Chinese grid emission factors: (IGES (Institute for Global Environmental Strategies), 2021).

Pulp and paper energy efficiency measures

Chapter	Measure	Process
4.1	Batch Digester Improvement	Chemical Pulping
4.2	Lime Kiln Modification	Oxygen Enrichment
		High-Performance Refractory
4.3	Black liquor Evaporator	Chemical Recovery
4.4	High Efficiency Refiner	Mechanical Pulping
4.5	Waste Heat recovery	Radial blowers
		Thermo-Compressors
		Paper Machine Hood
4.6	Shoe Press	Paper Making
4.7	Stationary Siphon and Drying Bar	Paper Making
4.8	Steam Traps Maintenance	Steam System
4.9	Real-Time Energy Management System	All processes
4.10	Energy-Efficient Frequency Inverter for Pumps, Fans, and Compressors	All processes
4.11	Drying of Biofuel and Sludge with Utilizing Excess Heat	Chemical Recovery
4.12	Waste Incineration Plant	Chemical Recovery
4.13	Biogas from Sewage Plant	Chemical Recovery
4.14	Combined Heat and Power Production	Chemical Recovery

4.1 Batch Digester Improvement

4.1.1 Description of Baseline Situation and Energy Consumption

To separate wood/biomass fibers, it is necessary to remove lignin from the fiber walls and the middle lamella. This process is done by chemical pulping. It is important that the chemicals and the energy are uniformly transported through each chip (wood or other biomass chips) in the digester. Chips are heated with steam to reduce their air content and increase the cooking liquid absorption.

The lignin reaction in kraft pulping is carried out in the impregnation phase, known as initial delignification, and in the cooking phase. Only 20 – 25 % of the lignin is dissolved in initial delignification but it improves the penetration of the cooking liquor into the chips during the next step: the cooking phase. In a batch digester, preheated chips and the liquors are cooked at a higher temperature and pressure. After reaching the desired residual lignin content, the content is discharged and the cooking process is repeated. (Suhr, et al., 2015)

Simplified batch digester system

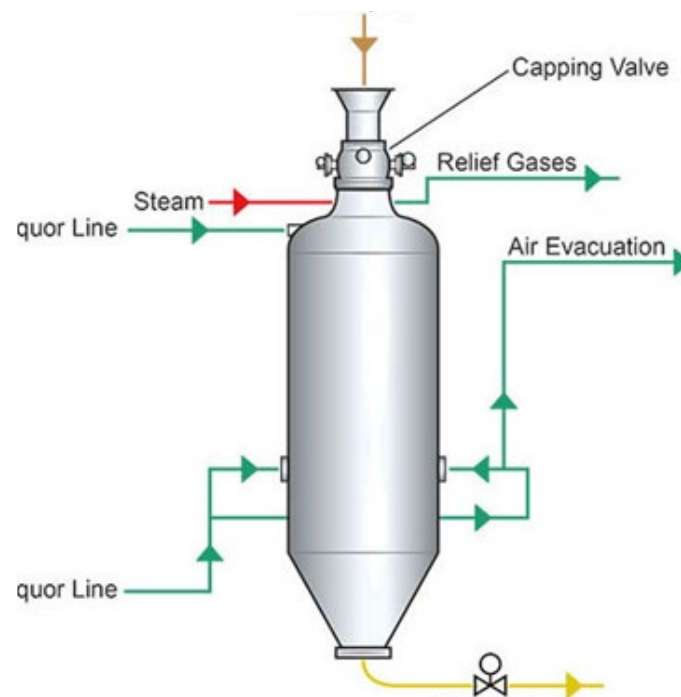

Source (NAF Control Valves, 2021)

4.1.2 Suggested Measures of Improvement

In recent years, the batch cooking system has been developed significantly. New systems explained in the following chapters, use less energy, increase the pro-

duction capacity, and improve the working environment by reducing volatile organic compounds.

Indirect Heating

Indirect heating through heat exchangers and forced liquor circulation leads to an improved cooking uniformity, and elimination of cooking liquor dilution in comparison to the conventional process. The cooking liquor is withdrawn from the batch digester, pumped through an external heat exchanger, and returned into the digester which results in reducing direct steam loads. This requires the liquor to be moved from the chip mass within the digester to the extraction lo-

cations. This movement happens through the space between chips and occurs when there is enough open texture among the mass of the chip. The preferred acceptable chip sizes is less than the maximum of 8 mm.

This modification requires a circulation system with a pump, an external heat exchanger, and a strainer section in the digester walls.

Cold-Blow Technology

This technology is applicable to kraft pulping for different types of woods. The disadvantage is the high cost of replacing the existing digester. Normally, a replacement cannot be justified unless there is a production increase or the condition of the present equipment motivates the complete replacement of the existing digesters (National Council for Air and Stream Improvement (NCASI), 2001).

The hot spent pulping liquor is displaced from the digester contents using brown stock washer filtrate at the end of the cooking cycle. In this way, the steam requirements for heating the digester contents are reduced. Also, the recovered black liquor can be used for preheating and impregnating incoming wood chips, and heating of other process inputs, such as white liquor or process water (Kramer, Masanet, Xu, & Worrell, 2009).

Cold-blow systems generally result in lower steam and heat consumption. This is because part of the heat in the black liquor is recovered to be used in the next cooking cycle. Also, the recovered black liquor can be used for preheating and impregnating incoming chips or for heating white liquor or process water. Besides, the replacement of the existing batch digester system with a cold-blow system would result in a reduction of the bleaching chemicals.

As mentioned, this technology reduces digester steam demand and boiler fuel consumption. Reduced steam consumption in cooking would reduce operating costs. The reduction would depend on the number and size of the digesters, but savings would be significant.

Illustration of Cold-Blow Technology

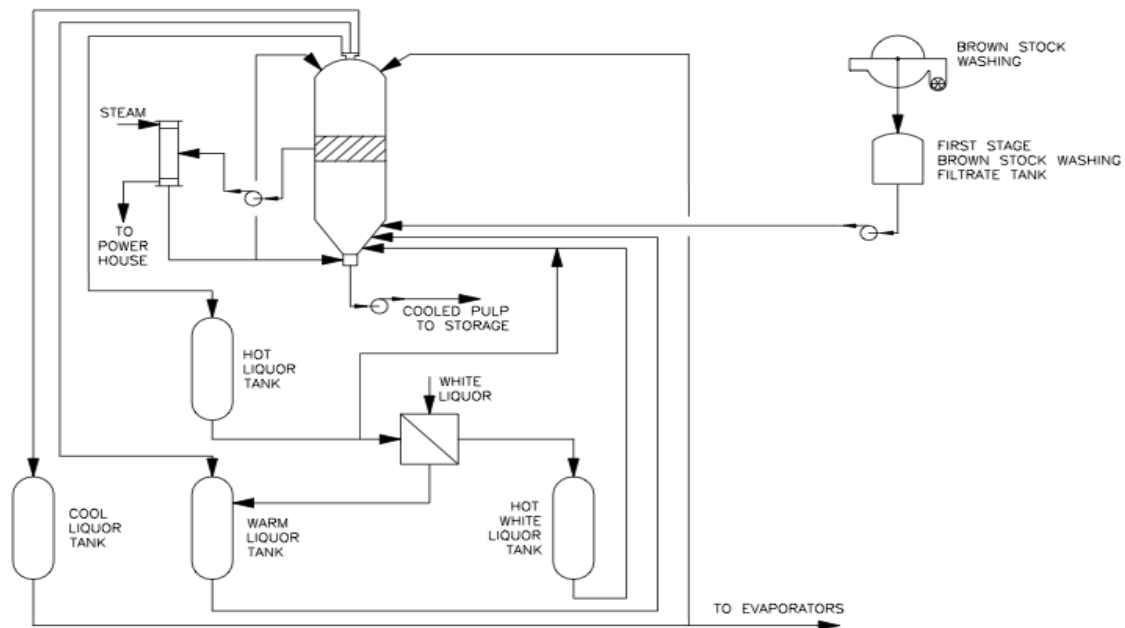

Source: (Suhr, et al., 2015)

4.1.3 Potential Energy Savings and Greenhouse Gas Emission Reduction

Indirect heating is done by drawing cooking liquor from the digesters and pumping it through an external heat exchanger, then returning to the digesters at two separate locations. Cold-blow systems displace hot spent cooking liquor from the digester contents (chips, cooking liquor, air, etc.) using brownstock washer filtrate. Heat can be recovered from the spent liquor for heating subsequent cooks, which reduces cooking steam consumption.

An analysis by Berkeley National Laboratory on Chinese pulp and paper industry, shows a 880 kWh/t_{product} final energy saving by implementing indirect heating and cold-blow system in comparison to conventional process. Capital cost is estimated to be around 4.80 €/product.

Key facts of measure - Batch Digester Improvement

Key facts of measure - Batch Digester Improvement (Indirect Heating and Cold-Blow Technology)	
Investment Cost:	4.80 €/product _{pulp}
Energy Savings: (thermal and electricity)	880 kWh/t _{product}
CO ₂ mitigation:	0.3 t CO ₂ /t _{product}
Advantage:	<ul style="list-style-type: none"> • Increased capacity (up to 30 %) • Reduced fuel consumption (oil, natural gas, etc.) • Reduced energy consumption • Low risk of hydrogen sulfide
Disadvantage:	<ul style="list-style-type: none"> • High cost of replacement • Costly maintenance

4.2 Lime Kiln Modification

4.2.1 Description of Baseline Situation and Energy Consumption

Lime mud is a by-product produced in pulp mills as part of the process that turns wood chips into pulp for paper. A lime kiln uses heat, motion, and airflow to convert lime mud to lime. The reaction is called calcining: the conversion of calcium carbonate to calcium

oxide. The most common lime kiln at kraft pulp mills is the rotary lime kiln. Rotary lime kilns are large steel tubes or cylinders that are lined on the inside with refractory bricks. They are slightly inclined and slowly rotated on a set of riding rings.

Illustration of a pulp manufacturing process - Rotary kiln

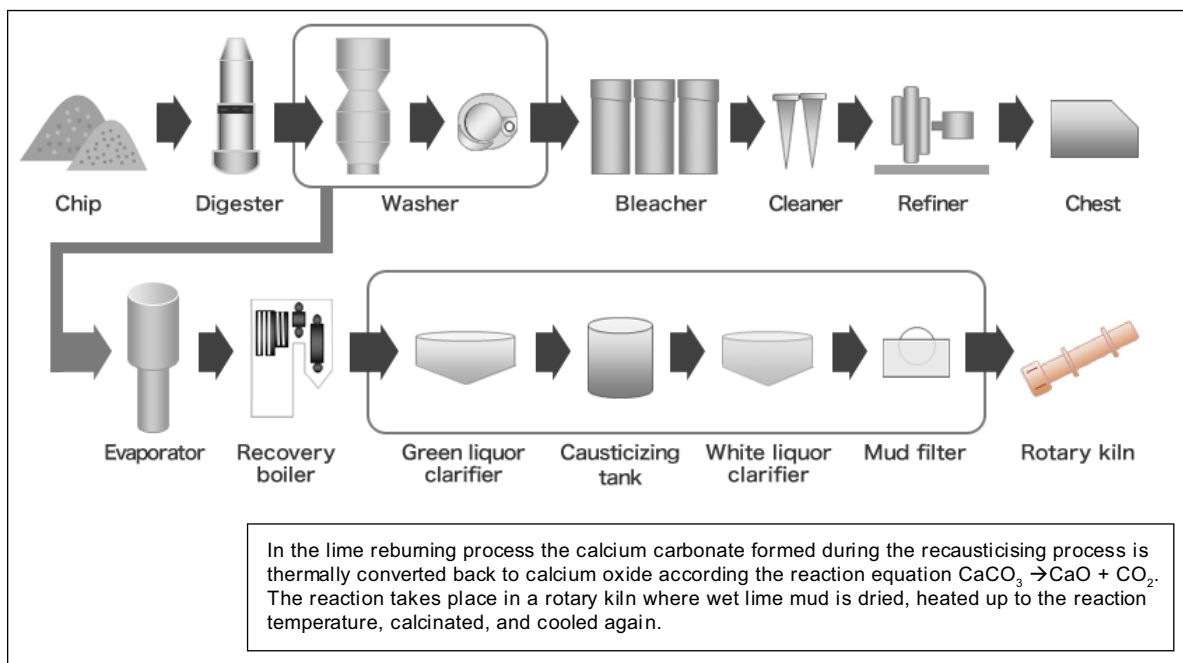

Source: Adopted form (Kurita, 2021)

Left: Exterior of a lime re-burning kiln, Right: Interior of a lime re-burning kiln

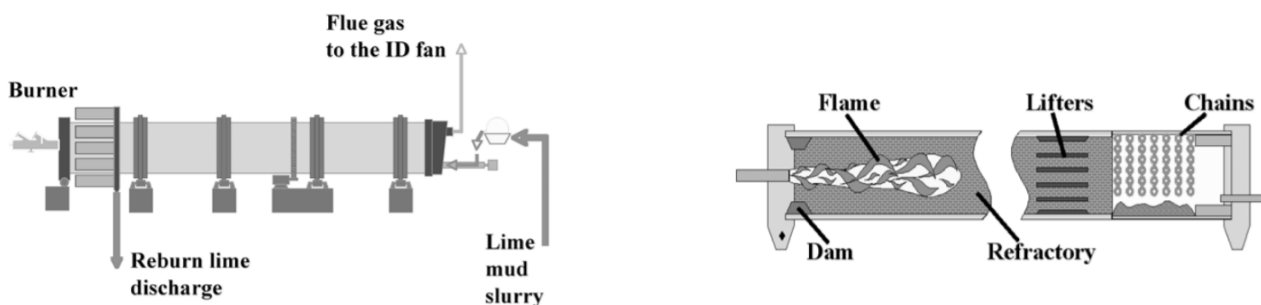

Source: (N.Adams)

Lime mud is continuously fed in from the higher end of the cylinder, and the rotation and inclination of the kiln make the mud move down slowly, towards the opposite end. A burner at the lower end of the kiln provides the heat needed for the calcining reaction, and an induced draft fan at the lime mud feed-end pulls the hot gasses through the kiln. The rotation of the kiln stirs the lime mud as it travels to be fully exposed to heat. There are three major sections that are named after the processes occurring within: the evaporation,

the heating, and the calcining sections. The largest consumer of fuels in a kraft pulp mill is the lime kiln, representing approximately 305 – 390 kWh/ADT⁸ heat input.

The size of the rotary lime kilns used in the pulp and paper industry range from 2.1 m in diameter by 53 m long to 4 m in diameter by 122 m long. Production capacities for these units range from 50 t/day of CaO to 450 t/day of CaO.

4.2.2 Suggested Measure of Improvement

Opportunities to improve the energy efficiency of lime kilns include oxygen enrichment and using high-performance refractory.

Oxygen Enrichment

The main objectives of lime kiln operation are uniform quality lime production, fuel consumption minimization, and compliance with environmental emission regulation. Oxygen enrichment is an established technology for increasing the efficiency of combustion. This technology has been used by industries using high-temperature combustion processes. Oxygen

increases the combustion of fuels and improves the burning zone. Also, by using this technique, the kiln stability increases, and emissions decrease. By increasing the oxygen concentration of combustion air through the addition of relatively pure oxygen, flame temperatures rise, heat transfer rates improve, and overall combustion efficiency increases.

A flame profile in a kiln with and without oxygen enrichment

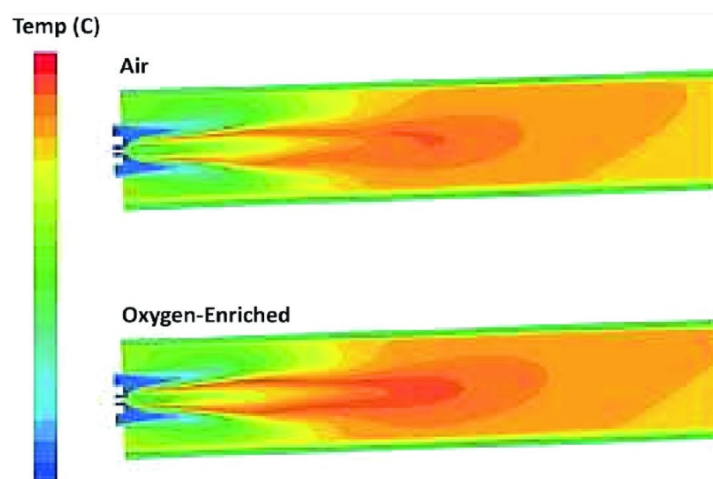

Source: (Mittal, Saxena, & Mohapatra, 2020)

⁸ specific chemical and energy consumption, costs and emissions are expressed as 'per 90 % air dry pulp'.

Oxygen enrichment increases the highest temperature zone around the core of the flame, while the temperature at the walls of the kiln has remained similar to

that of the conventional air combustion flame (s. figure above). This translates into increased production and reduced emissions.

High Performance Refractory

The refractory or the lining applied on the interior of rotary kilns ensures process efficiency and prolonging the life of a rotary kiln. Relining a lime kiln is a routine maintenance activity. A very common refractory system consists of bricks that are composed of special heat-resistant and chemical attack-resistant material (often alumina and silica). The bricks in the hot zone of the kiln near the flame are composed of 70 % alumina in order to resist the high temperature and chemical attack in this region. The bricks in about one-third of the way up the length of the kiln, are composed of 40 % alumina, which has better insulating characteristics.

Many modifications of refractories are available, including alumina magnesia carbon bricks or two brick systems that use insulating brick against the steel shell and chemical resistant bricks in contact with the lime solids and combustion gases. Figure 21 shows the arrangement for a simple brick and two refractory systems.

Rotary kiln refractory systems

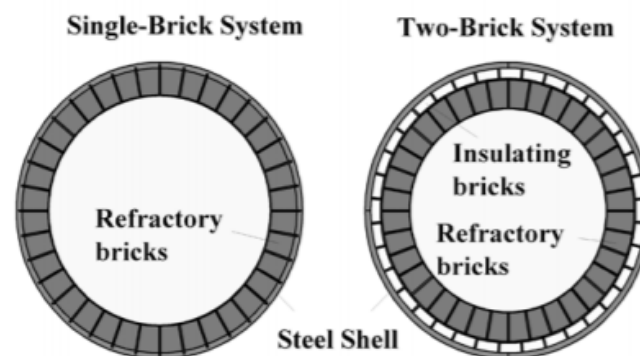

Source: (N.Adams)

4.2.3 Potential Energy Savings and Greenhouse Gas Emission Reduction

Oxygen is injected into the air stream feeding the lime kiln burners. The resulting kiln temperatures are higher and give rise to fuel efficiency. This technique is applied to the lime kiln that is used for calcinating lime in the sulfate-based pulping process. Oxygen enrichment of lime kilns can reduce fuel requirements by around 7 – 12 % and manufacturers claim achieving energy savings by up to 50 %.

Reportedly, capital investments for oxygen enrichment are low (costs less than € 100,000) with only feed piping, an injection lance, and controls required. Payback periods have been estimated between roughly one and three years (Focus on Energy, 2006).

Key facts of measure – Lime Kiln Modification, Oxygen Enrichment

Investment Cost:	less than € 100,000 (Focus on Energy, 2006)
Energy Savings: (thermal)	7 – 12 % fuel reduction (25 - 40 kWh/t _{pulp})
CO ₂ mitigation:	0.01 - 0.02 t CO ₂ /t _{pulp}
Advantage:	<ul style="list-style-type: none"> • Increased capacity (up to 30 %) • Reduced fuel consumption (oil, natural gas, etc.) • Reduced energy consumption • Low risk of hydrogen sulfide
Disadvantage:	<ul style="list-style-type: none"> • High investment • High running costs

With increasing fossil fuel costs, mills should re-examine their choice of lining materials to assure they are using the best available insulating refractory. Using high-performance refractory is suitable in the pulp mill area/lime kiln. Since the refractory is typically

gun-applied, installation takes less time than the traditional bricking method. This could increase lime kiln “up” time. The manufacturers claim energy savings of 5 %. In a typical mill, this would result in an annual saving of € 195,000 (Focus on Energy, 2006).

Key facts of measure – Lime Kiln Modification, High-Performance Refractory

Investment Cost:	The difference in cost between standard and high-performance refractory is less than 15,600 € for a typical kiln (Focus on Energy, 2006)
Energy Savings: (thermal)	5 % fuel reduction (17 kWh/t _{pulp})
CO ₂ mitigation:	0.007 t CO ₂ /t _{pulp}
Advantage:	<ul style="list-style-type: none"> • The potential of a “gunned” application, less time for implementing • Reduced fuel consumption (oil, natural gas, etc.)
Disadvantage	<ul style="list-style-type: none"> • Only applies to mills with lime kilns (i.e. Kraft mills)

4.3 Black Liquor Evaporator

4.3.1 Description of Baseline Situation and Energy Consumption

At a kraft pulp mill, evaporators are used for removing the water from and concentrating used pulping chemical solution. This is the first step in the process that is used for recovering the chemicals so that they can be re-used in the pulping process. Evaporation of the black liquor is an essential part of the chemical recovery process as it significantly concentrates the dry solids in the black liquor so that the liquor can be effectively burned in the recovery boiler. Black liquor is a complex solution of water, organic, and inorganic components. This composition varies from mill to mill, so the evaporation system must be flexible in design over a wide range of operating parameters.

Black liquor evaporators have several objectives. One, to heat and remove water from the black liquor efficiently so that it can be fired into the recovery boiler. Two, to avoid scale formation inside the evaporators. Three, to produce condensate or warm water that is clean enough for re-use in the pulp mill and recausticizing area in order to reduce fresh water usage. And four, to remove safely any volatile components and NCGs or non-condensable gases that are produced.

Illustration of example of a pulp manufacturing process – Evaporator

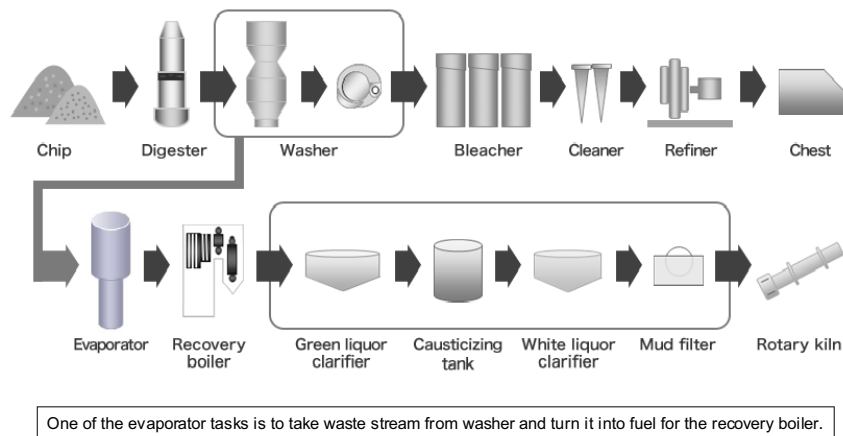

Source: Adopted form (Kurita, 2021)

Black liquor from pulp washing normally has a dissolved solids content of 14 – 18 % which has to be increased considerably before the liquor can be burnt. After the evaporation plant, the black liquor has nor-

mally a dry solids content of about 58 – 60 % which corresponds to a lower calorific value of around 7,000 kJ/kg. At atmospheric pressure, the upper limit for the increase of the dry solids is about 72 – 74 %.

4.3.2 Suggested Measure of Improvement

Minimizing the amount of water that needs to be evaporated, improves the boiler's thermal efficiency. This is achieved by increasing the dry solids content of black liquor fired in the recovery boiler. Increasing black liquor solids allows a greater throughput which

may allow for more virgin pulp production. Also, high solids firing in the recovery boiler improves the reliability of the recovery process and diminishes the risk of smelt-water explosive events.

The solids concentration of black liquor can be enhanced by installing a solids concentrator between the multiple-effect evaporator and the recovery boiler. An increase in the dry solids content of the black liquor from 65 – 70 % to 80 – 85 % changes the material and energy balances and the burning conditions in the recovery boiler. Increasing the dry solids content, for example to over 80 %, allows for an increase in production or extended delignification with a more efficient recovery of the black liquor. Experiences of

recently modernised plants show that pressurization of the liquor achieves dry solid concentrations of up to 85 %. Hence, higher temperatures in recovery boiler can be achieved, resulting in lower viscosity. In addition, the most effective way to reduce SO₂ emissions from kraft pulp mills is to operate the recovery boiler with a high dry solids content. The sulphur content of CNCG and the fuel oil burnt in the recovery boiler are less relevant for the reduction of SO₂ emissions.

4.3.3 Potential Energy Savings and Greenhouse Gas Emission Reduction

Operating on black liquor with a very highly dry solids content (> 80 %) leads to improved energy efficiency, allowing for integrated pulp and paper mills to operate self-sufficiently in terms of energy or even to generate excess energy, while at the same time resulting in lower sulphur and carbon monoxide emissions and decreased fouling. Most mills achieve emissions of <5 – 25 mg SO₂/Nm₃ or 0.01 – 0.10 kg SO₂-S/ADt of pulp.

The energy savings from installing a black liquor evaporator (with high solids concentration) on a 1,000 tonne per day black-liquor recovery system are estimated at a net of 59,000 kWh per day (Focus on Energy, 2006).

The process can be applied at both new and existing kraft mills. A superconcentrator can also be implemented as a separate phase to existing evaporation plants. In existing mills the cost of improving the evaporation and concentration of strong black liquor depends on the target concentration rate. According to the BAT, at existing mills with 1,500 ADt/d kraft pulp

production, the investment required for various levels of increased black liquor concentration (min. 63 % and higher levels) is as follows:

- Concentration from 63 % to 70 %: 1.7 – 2.0 million €;
- Concentration from 63 % to 75 %: 3.5 – 4.0 million €;
- Concentration from 63 % to 80 %: 8.0 – 9.0 million € (Suhr, et al., 2015).

It is important to note that increasing dry solids increases furnace temperatures and decreases sulphur emissions, but increases NO_x emissions, if no counter measure is taken. Running recovery boilers with a highly dry solids content and high furnace temperatures maximises the electricity production from the boilers. Also, the reduction of sulphur emissions due to high dry solid contents increases the emissions of particulates prior to flue-gas cleaning. This requires the installation of a more efficient and expensive electrostatic precipitator. At a very high dry solid content (>80 %) there is a considerable release of sulphur compounds from the last evaporator stage, which has to be collected and incinerated.

Key facts of measure – Black Liquor Evaporator (Solids Concentrator)

Investment Cost:	Depending on the concentration increase rate, between 1.7 - 9.0 million € The ROI on this type of installation is estimated at 7 % to 14 %.
Energy Savings:	59 kWh/t _{black liquor}
CO ₂ mitigation:	0.023 t CO ₂ /t _{black liquor}
Advantage:	<ul style="list-style-type: none"> • Thermal efficiency • Lowers sulfur compound emissions • Reliability of the recovery process • Improve productivity by 2 %
Disadvantage	<ul style="list-style-type: none"> • Increases emissions of particulates prior to flue-gas cleaning, requires installation of more efficient and expensive electrostatic precipitator

4.4 Refiner Improvements

4.4.1 Description of Baseline Situation and Energy Consumption

The objective of the refiner process is to soften lignin bonds and fibrillation of the wood fibers. For many paper grades, pulp refining is an essential process step

to achieve the required paper properties. Refiners are used for mechanical pulping (TMP refiners) and the post-refining of GWP (Groundwood Pulp) mills.

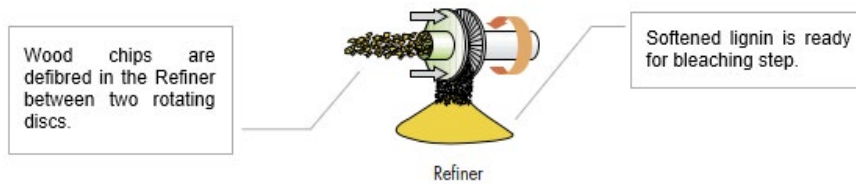

Figure 23: Schematic view of a refiner

The refiners use large amounts of electrical power, which is converted into heat and steam through friction. Electrical energy is mostly used for driving the rotor in the refiner. The energy input largely depends on the raw material and the paper properties. The table

below shows the typical net power consumptions for refining different types of the end product. The data refers to the net electrical energy, i.e., the energy absorbed per fiber (kWh/tonne), which is introduced into the fibers as grinding power.

Typical power consumption in refining by product⁹

Type of paper	Net energy for refining (kWh/t)	Remarks
Tissue	Up to 30	Refining in bypass mode, not total volume
Printing and writing	60-200	Depending on mixture of long and short fibres
Carbonless papers	150-200	Depending on mixture of long and short fibres
Glassine/Greaseproof papers	450-600	Depending on mixture of long and short fibres
Tracing papers	800-1200	Depending on mixture of long and short fibres

Source: (Suhr, et al., 2015)

4.4.2 Suggested Measure of Improvement

No-load power which is caused by motor, pumping, and friction losses, can be reduced by implementing a high-efficiency refiner. Depending on the application, the no-load power can amount to 30 – 50 % of the refiner's energy consumption. Significant energy savings can be achieved when replacing existing refiners with new high-efficiency refiners. This is the focus of this sub-chapter.

The applicability of a high-efficiency refiner to new or existing plants using virgin paper depends on the used raw material and required paper or pulp properties. The modification of the refining operation can be applied to mills in which either the refining plant is oversized or operated in an inefficient mode. In order to ensure a reliable operation, the capacity of the feed pump, refining, and storage chests may require adaptation.

⁹ Net energy is derived from the gross power minus the idle load or free running power. Gross energy is the total electrical energy consumed including the losses. Gross energy = Net energy × 1.3 – 1.5. The idle load of a refiner is the power that is taken up by mechanical drag and turbulent forces and is therefore not available to treat the fibres.

4.4.3 Potential Energy Savings and Greenhouse Gas Emission Reduction

In a case study (specialty base paper, 50,000 t/year), two refiners were working in a sequential mode (continuous process). The workload of both units was approximately 50 % of the installed power; the idle power (no-load power) was almost 40 % of the total power consumption. Changing the operation mode to batch operation, achieved power savings of 18 %.

In a graphic paper mill, energy savings of 110 kWh/ $t_{\text{refined pulp}}$ compared to the formerly used cone refiners

were achieved by use of optimized refiners. It is important to mention that the amount of energy-saving potential strongly depends on the raw material used and the required refining result (e.g., multi-disc or double cylinder refiners) (Suhr, et al., 2015). A change in the refiner's equipment means a significant change in the process, which is associated with high investment costs. The table below gives a simplified economic assessment of the use of high-efficiency refiners for short-fiber refining.

Cost calculation for a refiner (300 bone dry tonnes/day) for hardwood refining

Cost-relevant aspects	Energy use	Cost/savings
Mill consumption without high efficiency refiners	2 145 kWh/t	
Mill consumption with high efficiency refiners	2 100 kWh/t	
Power savings(12%)	45 kWh/t or 9 770 MWh/year	EUR 488 500/year
Carbon dioxide	6 077t/year	EUR 91 155/year
Total savings(power,prevented CO ₂ emissions)		EUR 580 000/year
Investment for the high efficiency refiner	800-1200	EUR 600 000
Payback time:1 year		

Source: (Suhr, et al., 2015) (Blum et al., 2009)

Key facts of measure – High Efficiency Refiner

Investment Cost:	600,000€
Energy Savings: (electricity)	7 – 20 % electricity saving depending on the application 20-45 kWh/ t_{paper}
CO ₂ mitigation:	0.012 - 0.03 t CO ₂ / t_{paper}
Advantage:	<ul style="list-style-type: none"> • Saving power due to lower no-load power • Cost reduction • Improvement of product quality is possible
Disadvantage:	<ul style="list-style-type: none"> • High investment costs • The capacity of the feed pump, refining and storage chests may need to be adapted to ensure a reliable operation.

Additional savings can be achieved by improving the existing refining plants through the optimization of

the feed pumps, the workload or the mode of operation.

4.5 Waste Heat Recovery

4.5.1 Description of Baseline Situation and Energy Consumption

Almost all the heat energy consumed in a paper mill is used for paper drying, making the dryer section easily the biggest consumer of energy in a paper machine. A large amount of the thermal energy used in the drying

process ends up in the exhaust air, so a heat-recovery system is vital to the overall energy economy of the papermaking process (Martin, et al., 2000).

Paper machine structure - Dryer section

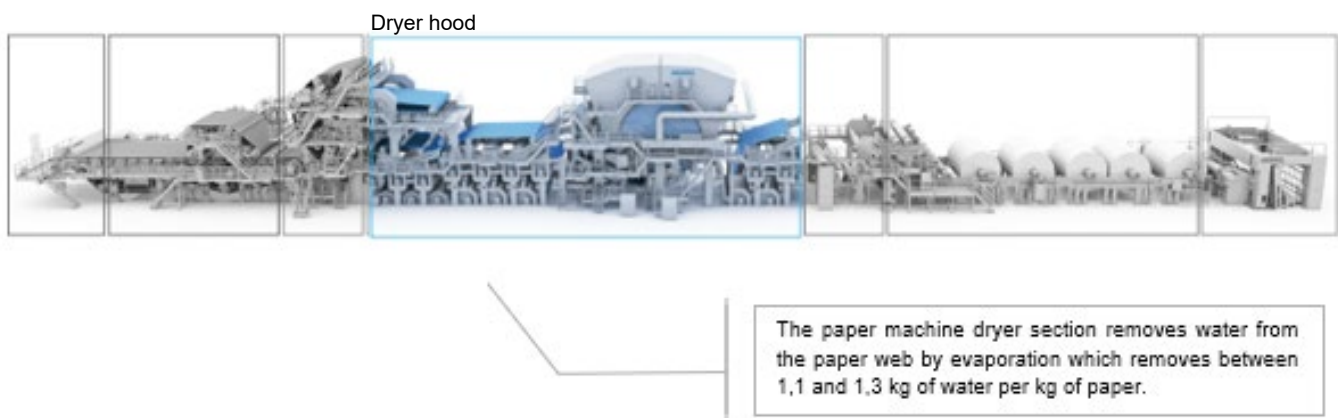

Approximately 80 % of the energy required in the dryer section is brought as primary steam to the dryer cylinders. The remaining 20 % stem from drying and leakage air, and the paper web. Almost all the energy leaving the dryer section is exhausted with the exhaust air. The temperature of the exhaust air is normally 80 – 85 °C and the humidity is 140 – 160 g_{H₂O}/kg_{dry air} (Suhr,

et al., 2015). A rough overview of the dryer section of a paper machine is presented in the following figure. The energy flows in the paper machine in the form of steam, condensate, air, water streams, and paper. The challenge is identifying areas, in which energy is wasted and savings are possible.

Schematic of the paper dryer section of a paper machine

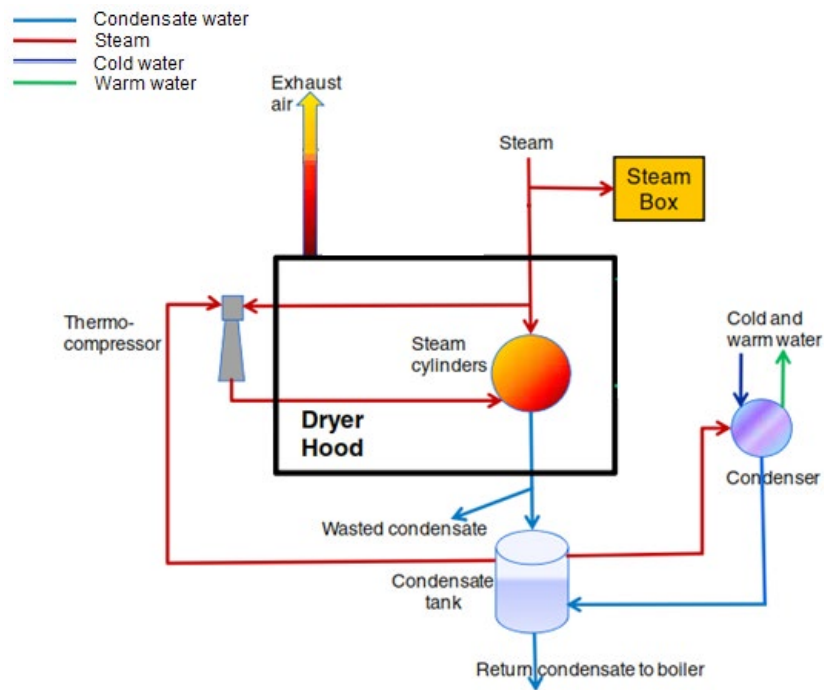

Source: (Bhutania, Lindberg, Starr, & Horton, 2012)

Commonly used indicators measuring the drying performance include the evaporation rate (kg water evaporated per unit area of the dryer) and the energy consumption per unit of product (kg steam per kg of product). The theoretical minimum energy required to evaporate a kilogram of water in a conventional cyl-

inder dryer section is about 1.24 kg of steam per kg of water.

The table below shows an example of heat flows (recovery and losses) in a typical large, modern paper machine¹⁰. As it can be seen large excess heat is available.

Example of heat recovery and heat losses of a paper machine with a production of 667 t/d

Sources of heat recovery	Heat losses from drying section	Distribution of heat(%)
Suppil air	1.8 MW _{th} or 233 MJ/t	6
Wire pit water	3.6 MW _{th} or 466 MJ/t	11
Fresh water	5.5 MW _{th} or 712 MJ/t	19
Circulation water	8.0 MW _{th} or 1 036 MJ/t	27
Exhaust to atmosphere	10.8 MW _{th} or 1 399 MJ/t	37
Total(Exhaust air from hood)	29.7 MW _{th} or 3 847 MJ/t	100

Source: (Suhr, et al., 2015)

¹⁰ The production capacity of the machine is 240,120 t/yr (667 t/d). The dry content of the web entering the dryer section is 44.5 % and leaving is 91 % dryness. The temperature of the exhaust air is 82 C and the humidity is 160 g H₂O/kg dry air. The values are for Scandinavian winter conditions (-15 to 4°C).

4.5.2 Suggested Measures of Improvement

The purpose of a heat recovery system is to reduce the mill's consumption of primary energy by using the above described existing waste heat from the process in an economically profitable way. A heat recovery

system can be applied both at new and existing plants. Excess heat can be recovered by implementing radial blower in the vacuum system, using thermo-compressors or from paper machine hood.

Heat Recovery from Radial Blowers Used in The Vacuum System

Radial blowers are used for wire and felt de-watering across all grades and are normally installed in larger paper machines. By re-using the recovered heat, the steam demand in the drying section of the paper machine can be reduced. The waste heat from the exhaust air can be used for heating the supply air of the drying hood, resulting in savings of direct steam.

Due to the compression process in the vacuum blower(s), the exhaust air from the blowers reaches temperatures of 130 – 160°C. This hot air can be passed through air-to-air heat exchangers, enabling the re-

cuperation of up to 75 % of the power absorbed by the vacuum blowers.

The radial blower can be applied in new and existing plants for all grades of paper. By applying the radial blower in the vacuum system, the pressure on the outlet needs to be high enough to overcome the pressure drop in the heat exchanger. However, normally the distance between the de-watering section of the paper machine where the blower is installed (heat source), and the drying section (heat sink), is short.

Use of Thermo-Compressors

Another measure that leads to steam saving in the drying section is using thermo-compressors. The use of thermo-compressors increases the energy efficiency of the drying process because less steam has to be

sent to the condenser. This is achieved by increasing the pressure of the exhaust vapors from separators (Suhr, et al., 2015). Figure 26 gives a schematic view of the use of thermo-compressors.

Schematic of a thermo-compressor

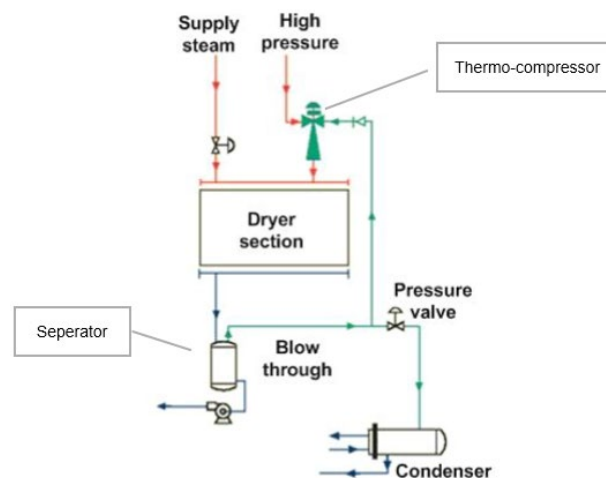

Source: (Suhr, et al., 2015)

Installing thermo-compressor is a common practice in all new paper mills and also in most of the rebuild paper machines. Medium-pressure steam is needed

to implement thermo-compressor. For most applications, a steam pressure of 5 to 12 bar has to be available.

Paper Machine Hood Heat Recovery

Some paper machines hood are without heat recovery system. This measure aims to adding a heat recovery system to a machine hood without heat recovery system. The two main goals of a paper machine dryer hood air system are to remove the water vapor that is evaporated from the sheet in the dryer section and

to control the temperatures, humidity, and air flows around the sheet in the pockets across the full machine width. The hood air system increases the drying capacity of the machine, improves sheet moisture profiles, reduces stain requirements, and improves the runnability of the dryer section.

Hood air system, dryer section

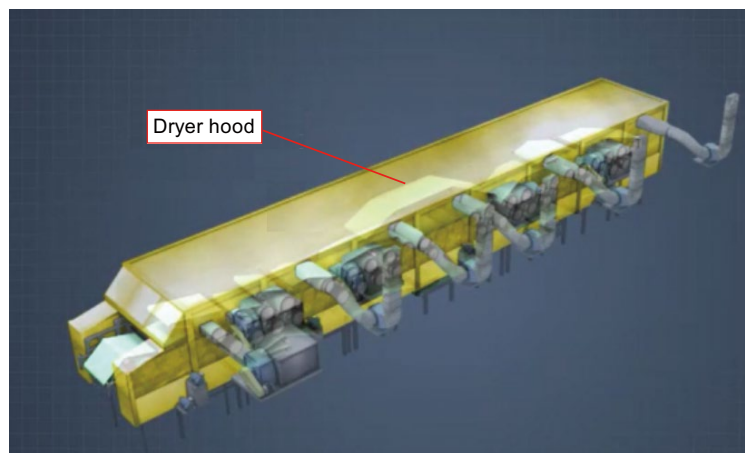

4.5.3 Potential Energy Savings and Greenhouse Gas Emission Reduction

By re-using the recovered heat, the steam demand in the drying section of the paper machine can be reduced. The waste heat from the exhaust air can be used for heating the supply air of the drying hood, resulting in savings of live steam.

Radial blower installations usually have short payback times. The economic efficiency is case-specific. In an

example plant, achieved steam savings amounted to 26 kWh/t and the payback time was 1.5 years (Blum et al., 2009) In some cases, the humidity remaining in the blowers has a corrosive potential. Regular maintenance avoids unnecessary and expensive shutdowns due to blocking or corrosion damage. (Suhr, et al., 2015).

Key facts of measure – Waste heat recovery, Radial blowers

Key facts of measure – Radial blowers	
Investment Cost:	Case-specific, less than 2 years payback time
Energy Savings: (thermal)	20-30 kWh/t _{paper}
CO ₂ mitigation:	0.008 – 0.012 t CO ₂ /t _{paper}
Advantage:	<ul style="list-style-type: none"> • Cost reduction due to steam savings • Increase in production rate • Higher drying capacity
Disadvantage:	<ul style="list-style-type: none"> • Corrosive potential

Economic efficiency of implementing thermo-compressors depends on the situation. Normally the payback time is less than one year. In an example plant,

achieved steam savings are 25 kWh/t and the payback time was 0.8 years (Blum et al., 2009).

Key facts of measure – Waste heat recovery, Thermo-Compressors

Key facts of measure – Thermo-Compressors	
Investment Cost:	Case-specific, payback time is less than one year
Energy Savings: (thermal)	25 kWh/t _{paper}
CO ₂ mitigation:	0.01 t CO ₂ /t _{paper}
Advantage:	<ul style="list-style-type: none"> • Energy savings for steam
Disadvantage:	<ul style="list-style-type: none"> • Increase need of high pressure steam

Paper machine hood exhaust typically contains a significant amount of energy. Using heat recovery, much of this energy can be reclaimed and returned to the process. This technology is applicable to the dryer section of the paper machine, but may also include other sources (e.g., vacuum pump exhaust). Large energy

savings potential depending on hood exhaust volumes, temperature, humidity, heat demands, etc. Savings in the order of 3,200 kW are possible. Depending on machine size and speed, and type of hood, the payback time ranges between 12 to 24 months (Focus on Energy, 2006).

Key facts of measure – Waste heat recovery, Paper machine hood

Key facts of measure – Paper Machine Hood	
Investment Cost:	From 1 – 2 years payback time
Energy Savings: (thermal)	Savings in the order of 3,200 kWh per hour 200 kWh/t _{paper}
CO ₂ mitigation:	0.07 t CO ₂ /t _{paper}
Advantage:	<ul style="list-style-type: none"> • Saving energy • Reduce exterior ice accumulation and stack noise emissions
Disadvantage:	<ul style="list-style-type: none"> • -

4.6 Shoe Press

4.6.1 Description of Baseline Situation and Energy Consumption

After the paper is formed, it goes through the wire and press section to remove as much water as possible. Normally, the web dryness after the press section is 45 - 50 % (about 1 kg water/1 kg furnish is left). To evaporate

the remaining water, almost 580 kWh/t steam in the drying section is needed. The higher the dryness of the paper web after the press section, the lower the thermal energy needed for the final paper drying.

Paper machine structure - Press section

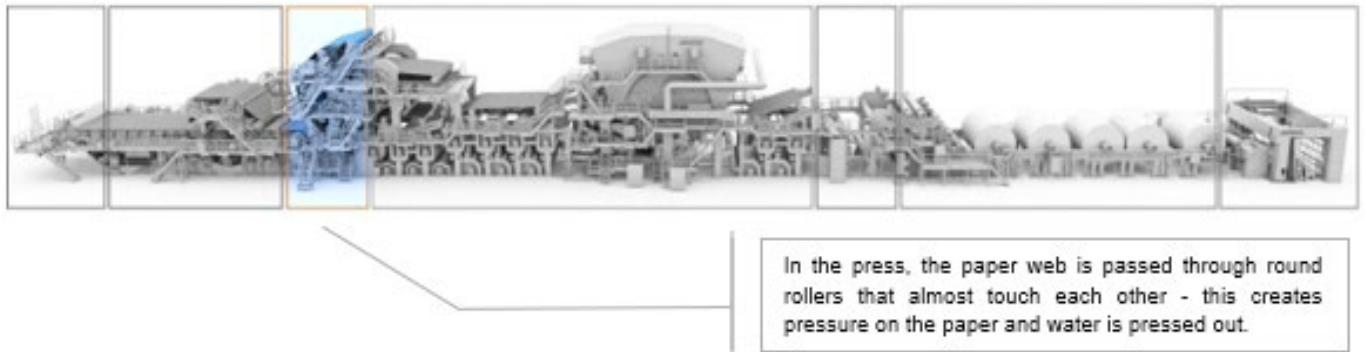

Typically, pressing happens between two felt liners between two rotating cylinders. In a conventional roll

press nip, the nip pressure cannot be further increased to improve de-watering in the press section.

4.6.2 Suggested Measure of Improvement

Shoe press/wide nip press technology is a papermaking procedure that improves de-watering in the wet pressing section, therefore, reducing the need for evaporation drying (Martin, et al., 2000).

This technology improves the de-watering capacity by extending the time that the paper sheet remains

in the press nip. This time is known as nip residence time. The amount of water removed in the pressing section is proportional to the magnitude and duration of the pressure applied to the paper sheet. The product of pressure and nip residence time is called the “press impulse” (MacGregor, 1989).

Left: Illustration of the conventional -press technique, Right: Press nip in tissue paper machine



Source: (Nygårds, 2016)

A pressure impulse, which is higher than the one in a conventional roll press, is obtained by substituting conventional short nip presses with wide nip press(es). Shoe presses use a large concave shoe instead of one of the conventional rotating cylinders; this extends dwell time, thus improving mechanical de-watering compared to that of conventional roll presses (Kramer, Masanet, Xu, & Worrell, 2009) (Luiten, 2001).

The shoe press has been developed even for high-speed machines (up to 2,000 m/min). The shoe press can be applied both in new and existing paper ma-

chines and in many different grades of production and board. An important pre-requisite is sufficient space in the press section and building construction permits of higher weights. In some cases, the maximum load of the hall crane has to be increased due to the heavier shoe press rolls (Suhr, et al., 2015).

A practical and simple alternative for small and mid-sized production lines is a mini shoe press roll where the shoe press nip length is only 90 to 120 mm and the linear load is 250 to 400 kN/m. The following figure shows mini shoe press rebuilds.

Rebuild from conventional to shoe press

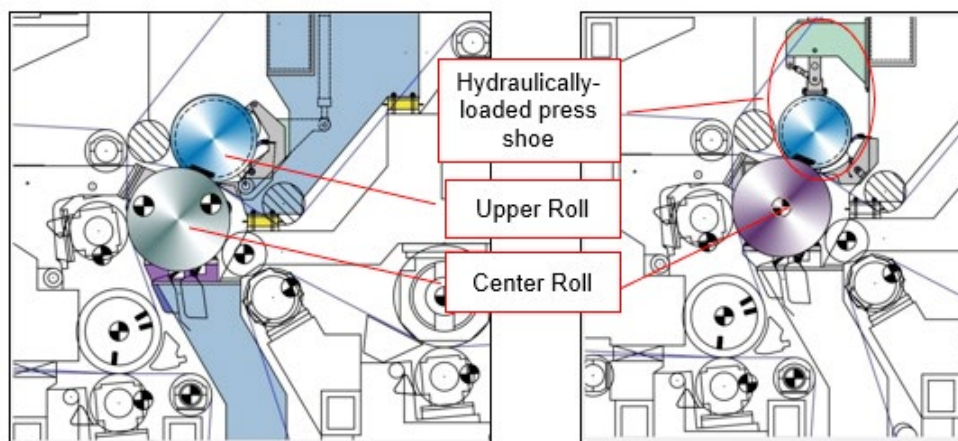

Source: (Valmet Forward, 2021)

The shoe press rebuild includes a shoe press roll with a minimized shoe length and roll diameter, and an optimized counter roll (solid roll) diameter. The rebuild can be carried out with minimal changes to the existing press section geometry, frame, and surrounding components, which significantly shortens shutdown time.

In conventional presses, both the pressure applied and the nip residence time are limited. Pressure can not exceed a certain threshold, because the paper

sheet would be damaged (especially at higher machine speeds). Additionally, nip residence time decreases with increasing machine speeds. Both factors constrain and limit the achievable press impulse of conventional roll presses. This is overcome by shoe press technology (Nygårds, 2016).

A comparison between a conventional press curve and a shoe press curve is illustrated in the following figure. The increased dwell time and decreased peak pressure of the shoe press are well pronounced.

Illustration of the difference between conventional (roll) press and shoe press curves. The areas under the curves are the press impuls (1 psi = 6.9 kN/m²)

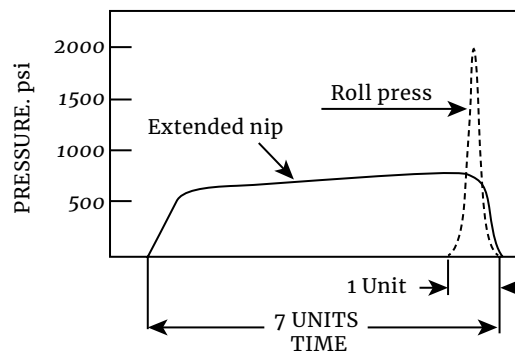

Source: (Wahlstrom, 1991)

4.6.3 Potential Energy Savings and Greenhouse Gas Emission Reduction

From the perspective of energy (and greenhouse gas saving), the major advantage is the reduced demand for steam in the drying section. This can lead to an improvement in energy efficiency. Although the shoe press has a higher specific electricity consumption due to configuration, in the end, the reduction in steam consumption is greater than the increase in electricity demand. Taking into consideration that producing one GJ of the steam needs more energy than producing one GJ of electricity, introducing the shoe press brings an enormous advantage in energy saving.

It is estimated that 3 % to 8 % of dryer steam can be reduced for every 1 % decrease in the water content of the web exiting the press section. In terms of kWh/tonne, an increase by 1%-3% dryness after the press, gives a thermal energy savings of roughly 60 – 180 kWh/tonne of product.

Replacing a roll press with a shoe press in a paper machine, the typical total savings in dryer energy are 20 – 30 %. The savings of steam for paper drying are in a range between € 10 and € 15 per tonne of steam, resulting in a specific steam consumption of 2 tonnes

of steam per tonne of paper and savings between € 20 and € 30 per tonne of paper.

The investment costs of a shoe press in a paper machine of 5 m untrimmed width total about € 10 million (including the whole installation) (Suhr, et al., 2015).

The operational costs for a shoe press are roughly identical to that of a conventional press. In press rebuilds, the typical repayment period of the investment is about 2.5 years, if there are no other limits in speed increase such as limitation of the head box or/and machine drive capacity (Suhr, et al., 2015).

One of the advantages of the shoe press is better runnability, which leads to 10 – 20 % of increased production capacity, when a shoe press is implemented on an existing system. By implementing the shoe press on a new paper machine, the drying section can be shortened which will eventually reduce the capital expenditure (Luiten, 2001). Considering constant paper production, improved strength characteristics and cost-saving can be obtained as a result of reduced steam demand for paper drying.

Key facts of measure – Shoe Press

Investment Cost:	10 million € including the installation for a paper machine of 5 m
Energy Savings:	60-180 kWh/t _{paper} by 1%-3% dryness increase after the press
CO ₂ mitigation:	0,01-0,07 t CO ₂ /t _{paper}
Advantage:	<ul style="list-style-type: none"> • Higher after-press dryness • Reduce thermal drying requirements • Opportunity to save bulk • Better final product quality • Increase in production
Disadvantage:	<ul style="list-style-type: none"> • High investment cost • Space requirement within the machine

4.7 Dryers Bars and Stationary Siphons

4.7.1 Description of Baseline Situation and Energy Consumption

The final drying is done in the drying section. This is achieved by several steam-heated dryers (cylinders or ‘cans’). Groups of multiple cylinders are operated together. The paper sheet runs over a large number of dryers. Moisture in the paper is removed as it passes over each subsequent dryer. Steam is used as the heating medium in a dryer and enters the dryer in a

saturated or near-saturated state. As heat is conducted through the dryer shell and into the sheet, the steam is condensed to a liquid, giving up its latent heat. Latent heat is the heat required to change water to steam at boiling temperature. This heat is released during the condensation of steam.

Paper machine structure - dryer section

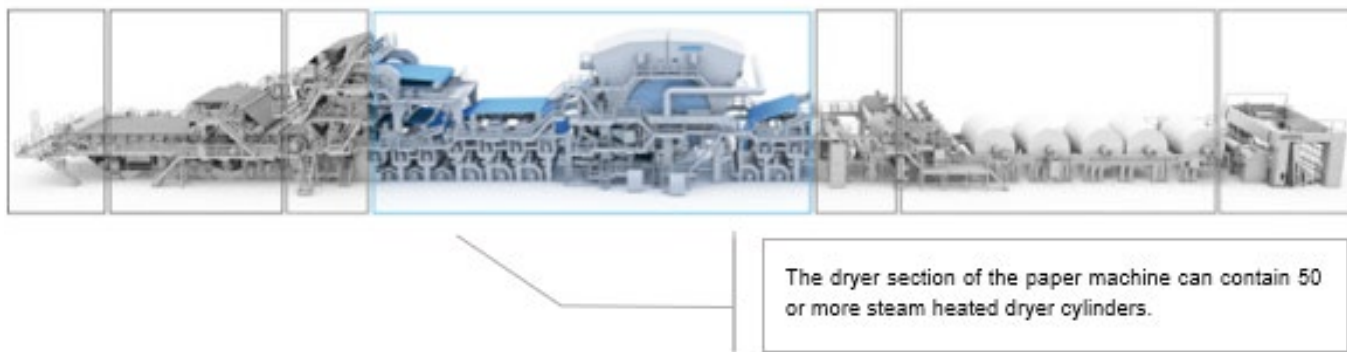





All pulp, paper, board, and the majority of tissue machines have steam and condensate systems at the dryer section.

The aim of the steam and condensate system in the paper machine is to provide the temperature for drying and to remove condensate. To heat the dryer cylinder, steam travels through a rotary joint into the dryer. As the steam condenses on the inside surface of the dryer shell, it releases its latent heat. Differential pressure

and blow-through system push the condensate into the siphon and back to rotary joint in the condensate return piping.

The table below shows the four (4) main stages of condensate behavior as the dryer rotation speed changes. The cascading stage offers the best heat transfer because of the very turbulent conditions inside the dryer, but the power surges may cause gear and bearing problems.

Four (4) main stages of condensate behavior in drying cylinders

	<p>Stage 1 – No rotation</p> <p>Condensate forms a pool in the bottom of the dryer cylinder</p>
	<p>Stage 2 – Puddling</p> <p>As the dryer begins to turn, the puddle moves up with the rotating dryer shell and a thin film of condensate forms around the shell surface.</p>
	<p>Stage 3 – Cascading</p> <p>Faster rotation of the dryer causes the puddle to move farther up the shell until gravity forces overcome centrifugal forces and the condensate showers back into the bottom of the dryer.</p>
	<p>Stage 4 – Rimming</p> <p>As the dryer rotation speed is increased further, centrifugal forces overcome gravity forces so that the film thickness is uniform all around the dryer shell.</p>

Condensate is removed from inside a rotating dryer with a siphon. The two main types of siphons are:

- Rotary siphons: fixed in the dryer and rotate with the dryer;
- Stationary siphons: held in a fixed position, and the dryer rotates around the siphons.

Main types of siphons in drying cylinders, a rotary (left) or stationary (right) siphon removes condensate from the inside surface of the dryer cylinder shell.

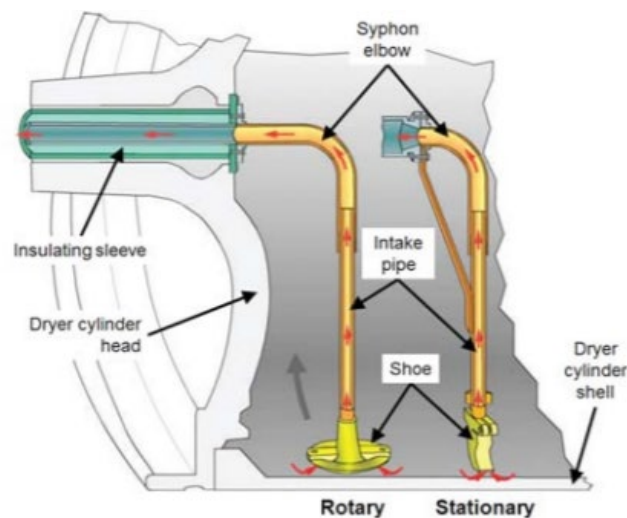

Stationary siphons are designed for a blow-through steam flow of 8 to 12 % of total steam consumed in the

dryer - rotary siphons may require 20 to 25 % blow-through steam to remove condensate adequately.

4.7.2 Suggested Measure of Improvement

The rotary siphon requires significant differential pressure in order to pull the condensate from the shell's inner surface. A stationary siphon may use a scoop-shaped shoe which will assist in pulling the condensate up into the siphon tube as the condensate

rotates around the shell, thus requiring less differential pressure to extract the condensate, therefore requiring less steam to operate. This potentially represents a significant cost saving.

As mentioned before, the stationary siphon remains in place as the dryer cylinder rotates and extracts condensate that is rimming the inside surface of the shell. In order to maximize the heat transfer in the rimming

condensate, turbulator bars are used. The size and position of the bars are designed to maximize this turbulent motion.

Dryer cylinder and stationary siphon, Left: without turbulator bar – Right: with turbulator bar

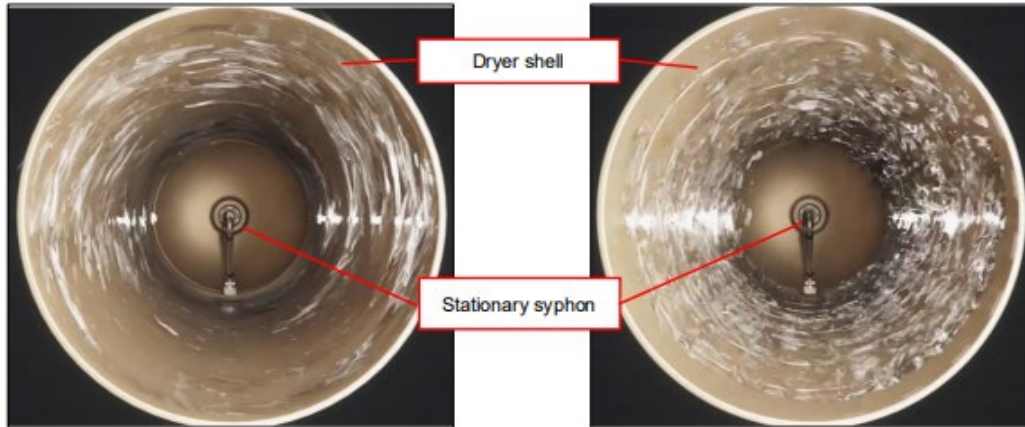

Replacing rotary siphons with stationary siphons in dryers that discharge directly to condensers can improve paper drying efficiency. A high-speed paper machine requires uniform and efficient heat transfer to dry paper. Dryer bars and stationary siphon incorporate the latest in drying technology, which manage

steam distribution heat transfer and condensate recovery inside a dryer cylinder. To achieve a high output speed, the required moisture must be removed from the paper in the fraction of a second after contacting the dryer shell.

4.7.3 Potential Energy Savings and Greenhouse Gas Emission Reduction

By employing stationary siphons and dryer bars the amount of “blow-through” steam needed to remove the condensate from a paper dryer is minimized. This technology is applicable to the dryer section of the paper machine. This is a well-known and widely accepted technology with full adoption on new/rebuilt machines but is better applied to paper machines running with dryers in “rimming” condition.

In addition to saving energy, this technology offers many other advantages ranging from more uniform cross-machine direction temperature profiles to less steam consumption. The steam saving associated with this technology range from 500 to 4,000 kg per hour. In a mill, replacing the dryers with stationary siphons saved 250 kWh/t paper due to enhanced drying efficiency (Kramer, Masanet, Xu, & Worrell, 2009).

Key facts of measure – Stationary Siphon and Drying Bar

Investment Cost:	Typically mills installing this technology see ROIs in the 25 to 80 % range.
Energy Savings: (thermal)	250 kWh/t
CO ₂ mitigation:	0.1 t CO ₂ /t _{paper}
Advantage:	<ul style="list-style-type: none"> Minimizes the steam consumed in drying paper
Disadvantage:	<ul style="list-style-type: none"> High investment cost Time consuming implementation

4.8 Steam Traps Maintenance

4.8.1 Description of Baseline Situation and Energy Consumption

Steam is used in a number of important applications throughout the typical pulp and paper mill, but by far most significantly in the cooking, bleaching, evaporation, and drying processes. Recovery boilers and power boilers are two primary sources of steam in pulp and paper mills. Recovery boilers are fired with black liquor to recover pulping chemicals and produce steam. Power boilers can be fired with multiple fuels and operate at high pressures.

The generated steam travels along the pipes of the distribution system to get to the process where the heat will be used. As the steam is used to heat processes, and even as it travels through the distribution system to get there, the steam cools and some is condensed into hot water. This hot condensate is removed by a steam trap.

Steam traps are automatic valves used in every steam system to remove condensate, air, and other non-condensable gases while blocking or minimizing the passing of steam. If condensate is allowed to be collected, within the piping and equipment, then it reduces the flow capacity of steam lines and the thermal capacity of heat transfer equipment. In addition, excess condensate can lead to “water hammers,” having potentially destructive and dangerous results. Air that remains after system start-up reduces steam pressure and temperature and may also reduce the thermal capacity of heat transfer equipment. Non-condensable gases, such as oxygen and carbon dioxide, cause

corrosion. Finally, the steam that passes through the trap provides no heating. This effectively reduces the heating capacity of the steam system or increases the amount of steam that is to be generated to meet the heating demand

The following functions are required of a steam trap:

- A rapid removal of drain water
- Removal of non-condensable gas such as air and CO₂
- Prevention of air leaks.

Steam traps have three failure modes: blocked, leaking, and blow-through. A blocked steam trap does not allow steam or condensate to pass through it. Steam traps are blocked by solid matter (e.g., rust chips); strainers are often installed on the upstream side of the trap to reduce the risk of blockage, but they can even be blocked under severe conditions. Depending on the type of steam trap, a normal steam trap passes no steam or a negligible amount of steam flow. A leaking steam trap passes an above-normal flow of steam, perhaps due to the valve inside the steam trap getting stuck in a partially open position.

In steam systems that have not been maintained for 3 to 5 years, approximately 15 to 30 % of the installed steam traps may fail. For thermodynamic steam traps, this percentage can be significantly higher. Steam traps are selected according to application and purpose. The available types of steam traps are described in the following Table.

Available types of steam trap and its features

Type	Features	Application
Disk type	(1) Small and light in weight (2) Steam lost in operation	Steam piping and headers
Free-float type	(1) Continuous discharge (2) Must be selected according to application	Heat exchangers, in locations where large amounts of drain water occur, primary piping
Bucket type	(1) Sensitive operation (2) Small steam lost (3) Leakage occurs with very small amounts of drain water	Heat exchangers
Bimetal type (temperature control)	(1) Drain water discharge temperature can be set (2) Drain water may collect	Tracing
Bellows type	(1) Low pressure use (2) Cheap (3) Problems with durability	Heating

Source: (New Energy and Industrial Technology Development Organization, 2008)

4.8.2 Suggested Measure of Improvement

Steam traps can be optimized through various techniques such as proper maintenance, monitoring, and improvement of the current equipment use. A simple program of checking steam traps to ensure that they are operating properly can save significant amounts of energy. In the absence of a steam trap maintenance program, it is common to detect up to 15 to 20 % of steam traps malfunctioning in a steam distribution system (Gardner, 2008). As with steam traps, steam distribution piping networks often have leaks that can go undetected without a program of regular inspection and maintenance.

Using automated monitors to steam traps with a maintenance program can save even more energy without significant added cost. This measure is an improvement over steam trap maintenance alone be-

cause it gives quicker notice of steam trap failure and can detect when a steam trap is not performing at peak efficiency.

Using more insulating material or using the best insulation material for the application can save energy in steam distribution systems. It is often observed that after heat distribution systems have undergone some form of repair, the insulation is not replaced. Removable insulating pads are commonly used in industrial facilities for insulating flanges, valves, expansion joints exchangers, pumps, turbines, tanks, and other surfaces. Insulating pads can be easily removed for periodic inspection or maintenance and replaced as needed. Insulating pads also contain built-in acoustical barriers to help control noise.

Removeable insulating pads

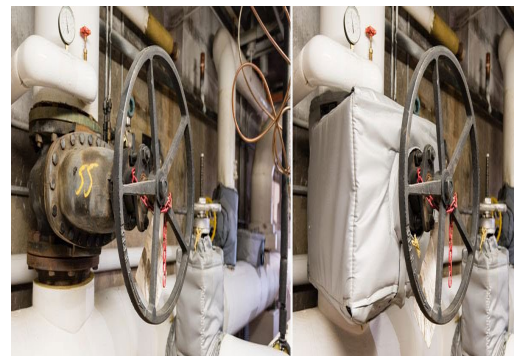
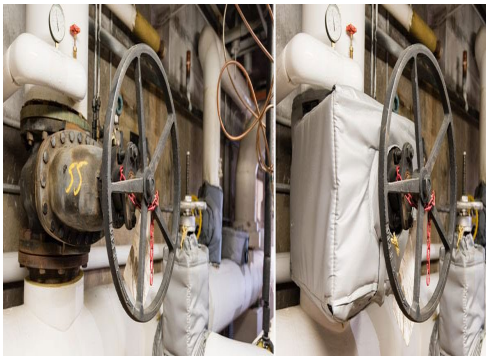

4.8.3 Potential Energy Savings and Greenhouse Gas Emission Reduction

A mill owned by Smurfit Kappa in Europe changed 25 steam traps to the venturi type¹¹ on a coating battery, which resulted in energy cost savings of nearly 140,000 € with a payback period of 2.5 months. Other projects saved 11 % on steam demand in the preheater and end corrugator rolls (10 steam traps), and a 30 % savings on a fluting machine (Gardner, 2008).

Energy savings for a regular system of steam trap checks and follow-up maintenance is conservatively estimated at 10 %. Employing steam trap monitoring

has been estimated to provide an additional 5 % in energy savings compared to steam trap maintenance alone, at a payback period of around one year (Kramer, Masanet, Xu, & Worrell, 2009).

According to a study conducted by Lawrence Berkeley National Laboratory, the energy savings, capital costs, and change in annual operations and maintenance (O&M) costs for this measure are 497 kWh/t product, 0.91 €/t product, and 0.04 €/t product respectively.

Key facts of measure – Steam Traps Maintenance

Investment Cost:	0.91 €/t _{product}
Energy Savings: (thermal)	497 kWh/t _{product}
CO ₂ mitigation:	0.19 t CO ₂ /t _{paper}
Advantage:	<ul style="list-style-type: none"> Increasing production safety
Disadvantage:	<ul style="list-style-type: none"> -

¹¹ Unlike most mechanical steam traps, a venturi orifice steam trap continuously removes condensate from a system.

4.9 Real-Time Energy Management System

4.9.1 Description of Baseline Situation and Energy Consumption

The need for energy management in a company arises from constantly increasing cost pressure. Cost pressure is an everyday reality. In addition, there is an increasing demand from politics and society to contribute to energy efficiency and climate protection. The aim of energy management is to optimize the use of energy in a company – from energy purchasing to energy consumption – both economically and ecologically.

Energy management is the sum of all measures planned and implemented to consume the least possible amount of energy at the maximum comfort level. Energy management, therefore, focuses on:

- Security of supply: reliable provision of energy to ensure the desired quality and comfort.
- Costs: savings in energy or energy costs and CO₂ emissions by improving the energy efficiency of processes, plants, and equipment, for example by recovering energy (heat) or changing energy sources (electricity to gas).
- Environmental protection: raising the awareness of users (employees) regarding energy efficiency and climate protection.

4.9.2 Suggested Measure of Improvement

Real-time energy management is a cutting-edge technology that continuously sends historical performance data to an advanced cloud-based system where it is transformed into actionable insights for the technical team, maintenance team, and industry manager.

A real-time energy management system may include sub-metering, monitoring, and control systems. It reduces the time required to perform complex tasks, often improves product and data quality and consistency, and optimizes process operations.

Machinery and equipment benefitting from energy management systems include boilers, evaporators, brown stock washers, lime kilns, paper machines, and wastewater treatment units. The energy management system can be tied into the current distributed control system as well as the operator control system to allow operators access to trend charts. The energy management system should allow for on-line reporting and accounting for energy usage in the unit, including steam, condensate return, fuel consumption, and other important process variables specific to each unit.

4.9.3 Potential Energy Savings and Greenhouse Gas Emission Reduction

Usually, measures for energy saving are related to investments to replace, rebuild or upgrade process equipment. The driving force for implementation is not only saving energy, but also increasing production efficiency, improving product quality, and reducing overall costs. It is therefore essential that energy-saving techniques are incorporated in all aspects and levels of papermaking.

Specific energy savings and payback periods for the overall adoption of energy monitoring and control systems vary significantly from plant to plant. A variety of process control systems are available for virtually any industrial process, and a wide body of literature is available assessing control systems in most industrial sectors. The table below shows a classification of control systems and typical energy efficiency improvement potentials.

Control systems and typical energy efficiency improvement potentials

System	Characteristics	Typical energy savings (%)
Monitoring and Targeting	Dedicated systems for various industries, well established in many countries and sectors	Typical savings 4-17%, average 8%, based on experiences in the UK
Computer Integrated Manufacturing (CIM)	Improvement of overall economics of process, e.g. stocks, productivity and energy	>2%
Process control	Moisture, oxygen and temperature control, air flow control "Knowledge based, fuzzy logic"	Typically 2-18% savings

Source: (Martin, et al., 2000)

Real-time energy management systems result in reduced downtime, reduced maintenance costs, reduced

processing time, and increased resource and energy efficiency, as well as improved emissions control.

Key facts of measure – Real-Time Energy Management System

Investment Cost:	3.22 €/t product
Energy Savings: (thermal and electricity)	111 kWh/t product
CO ₂ mitigation:	0.04 t CO ₂ /t _{paper}
Advantage:	<ul style="list-style-type: none"> • Increasing resource and energy efficiency • Reducing maintenance costs • Reducing processing time
Disadvantage:	<ul style="list-style-type: none"> • -

4.10 Energy-Efficient Frequency Inverter for Pumps, Fans, and Compressors

4.10.1 Description of Baseline Situation and Energy Consumption

In most paper mills, the flow of pumps, fans, and compressors is controlled by a throttling valve, while the equipment is running at a constant speed. Throttling valves are a type of valve that can be used for starting, stopping and regulating the flow of fluid through a rotodynamic pump. With the throttling valve control method, the pump runs continuously, and a valve in the pump discharge line is opened or closed to adjust the flow to the required value.

The figure below shows the control of pump flow by changing the system resistance using a throttle valve. With the valve fully open, the pump operates at Flow 2. When the valve is in the partially open position, it introduces an additional friction loss in the system, resulting in a new system curve that intersects the Pump curve at Flow 1, which is the new operating point. The head difference between the two curves' operating points shown is the head (pressure) drop across the throttling valve.

Control of pump flow by using a throttle valve

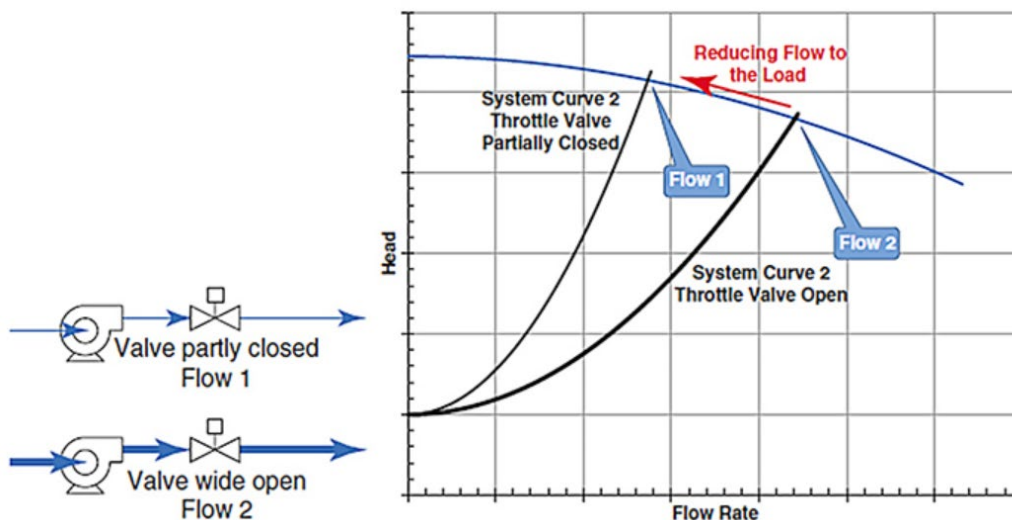

Source: (Pumps and systems, 2021)

It is the usual practice with throttling control to have the valve partially shut, even at maximum system design flow, to achieve controllability. Therefore, energy is wasted for overcoming the resistance through the valve at all flow conditions. As the flow rate decreases, a reduction in pump power in radial flow can be observed. However, the flow, multiplied by the head drop across the valve, is wasted energy that could have

been recovered, if speed control had been used as an alternative. On the other hand, using throttling control with mixed or axial flow pumps, where the pump power curve is normally increasing with the decreased flow, could lead to unacceptable increases in power consumption, which results in overloading the driver in addition to wasting energy.

4.10.2 Suggested Measure of Improvement

It is possible to operate the pump at higher efficiency values by varying the pump speed for changing mass flow rate. Adjustable-speed drives better match speed to load requirements for motor operations and therefore ensure that motor energy use is optimized to a given application. These kinds of pumps are usually called variable-speed pump (VSP) or variable frequency drive (VFD) pumps.

Figure 38 illustrates the power curves of a constant speed pump and VFDs. In the figure, the significant power consumption difference for the identical mass flow rate can be observed.

Comparison of fixed speed and VFD pump power curves

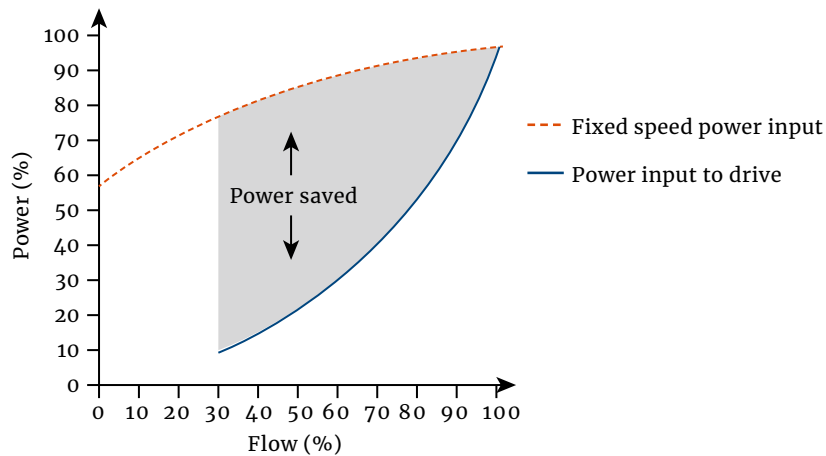

Source: (Shenzhen Gozuk, 2021)

With an inverter, the power frequency provided by the grid can be modified to adjust the speed of the asyn-

chronous motors (as the speed of an asynchronous motor is a function of the frequency).

4.10.3 Potential Energy Savings and Greenhouse Gas Emission Reduction

Frequency inverters can be applied to both new and existing plants using three-phase asynchronous motors. Motors that could be optimized with adjustable-speed drives include stock, liquor, filtrate, and paper machine pumps in pulp and paper mills; kiln and dryer fans in wood product facilities; boiler air fans; and any other pumps or fans with variable flows. The applicability of a frequency inverter in a wastewater treatment plant may be restricted when the wastewater flow is discontinuous and characterized by sudden changes.

Power savings for pumping applications are achieved

through lower throttling losses and higher hydraulic yield of the pump. Typical savings range between 15 % and 25 % for each application. Prices for frequency inverters have dropped significantly in recent years. Economic efficiency needs to be assessed for each situation. The payback period fluctuates between 0.5 and 4 years (Suhr, et al., 2015).

According to a study conducted by Lawrence Berkeley National Laboratory, on Chinese pulp and paper industries, the electricity savings and capital costs for this measure are 10.5 kWh/t product, and 0,69 €/t product, respectively.

Key facts of measure – Energy-efficient frequency inverter for pumps, fans, and compressors

Investment Cost:	0.69 €/t product
Energy Savings: (electricity)	10.5 kWh/t product
CO ₂ mitigation:	0.006 t CO ₂ /t _{paper}
Advantage:	<ul style="list-style-type: none"> • Cost reduction • Energy savings (power) • Process control
Disadvantage:	<ul style="list-style-type: none"> • -

4.11 Utilizing Excess Heat for Drying of Biofuel and Sludge

4.11.1 Description of Baseline Situation and Energy Consumption

Many pulp and paper mills have large amounts of biofuel (bark and wooden biomass), sludge (Chapter 4.13.1), and large sources of low-grade heat (excess heat) available. Currently, there are two industry-dominating sludge management strategies:

- Mechanical dewatering followed by composting (this Chapter)
- Mechanical dewatering and incineration (Chapter 4.12)

The mills are not compelled to perform sludge treatment on-site, and some mills choose to outsource the composting or drying to an external operator, with a subsequent increase in transportation requirements. The cost is directly proportional to the mass of solid waste for both strategies.

4.11.2 Suggested Measure of Improvement

Final cleaning rejects, fiber losses, and sludge that are generated during pulp and paper manufacturing and water treatment must be de-watered before final disposal or further treatment. De-watering aims at removing water from the sludge as much as possible, increasing the dry solids (DS) of the rejects, which would eventually mean a decrease in disposal costs.

Biological and chemical sludge is normally pre-dewatered prior to de-watering and thickening. This means an increase of DS content from about 1 – 2 % to 3 – 4 % or higher. The pre-dewatering of sludge is usually performed in gravity tables, gravity disc thickeners, hydrostatic disc thickeners, and, for bio-sludge, also by thickener centrifuges.

Mechanically, with belt presses, the rejects could be de-watered to a maximum of 40–50 % (with fiber sludge) and 25 – 40 % (with mixed fiber/biological/chemical sludge) dry matter. To increase the DS content after the belt press de-watering, a screw press can be used. However, a screw press requires the rejects to be shredded before the press, which increases the internal costs.

Significantly higher dry contents can only be achieved by thermal drying. With the use of a drying plant for the rejects, an increase from 50 % dry solids to 90 % dry solids can be achieved. An investigation of the available excess heat sources at the production site can determine the energy content of these heat sources and compare it to the energy needed for the drying process.

4.11.3 Potential Energy Savings and Greenhouse Gas Emission Reduction

Sludge de-watering can reduce the sludge volume and weight resulting in less volume for transport and disposal. Mechanical and thermal drying can result in 90 % dry solids output. The required thermal energy for this measure can be provided by waste heat from flue gas. It is estimated that the disposal costs of the rejects can be reduced by 50 %.

The drying of sludge can generate additional revenue (or reduced purchase costs for energy) and thereby also create incentives for further energy-saving mod-

ifications to the main process. The drying of biofuel and sludge is normally only economically viable if the excess heat from other processes can be used for this purpose.

The measure can generally be applied to both new and existing plants that have suitable excess heat sources for the drying of the biomass and sludge. Normally, excess heat such as hot air or hot process water flows can be used. Other more expensive options are steam heat exchangers or a gas-fired drying system.

Key facts of measure – Drying of Biofuel and Sludge with Utilizing Excess Heat

Investment Cost:	achievable savings and investment costs depend on specific mill characteristics and energy source for drying
Energy Savings:	
CO ₂ mitigation:	
Advantage:	<ul style="list-style-type: none"> • Reduction of weight leading to lower transport and landfill costs • To increase the calorific value prior to incineration
Disadvantage:	<ul style="list-style-type: none"> • Extracted humidity may cause an odour problem and needs to be controlled

4.12 Waste Incineration Plant (Using Sludge and Reject)

4.12.1 Description of Baseline Situation and Energy Consumption

See chapter 4.11.1

4.12.2 Suggested Measure of Improvement

In recovered paper processing paper mills without de-inking (e.g. Testliner, Wellenstoff, carton board or folding boxboard), around 4 to 10 % of input material become residues. These comprise the residues from pulper disposal system, the rejects from various screening and cleaning stages from the stock preparation plant, and sludge from waste water treatment. Most of these fractions are not suitable for material recycling (although compost can be produced from rejects from final cleaning and screening stages of paper machine loop). However, as they have a heating value

of around 6.1 – 6.7 kWh/kg dry matter, their incineration appears as a feasible waste management option.

After de-watering, the sludge and rejects can be dried in order to increase the heating value of the materials for energy recovery in incineration plants. Incineration further reduces the number of wastes sent from mechanical pulping to landfill disposal and recovers the energy content of the waste fractions. This technology reduces the fossil fuel consumption used in the steam generating boiler by the following process:

Waste incineration process steps

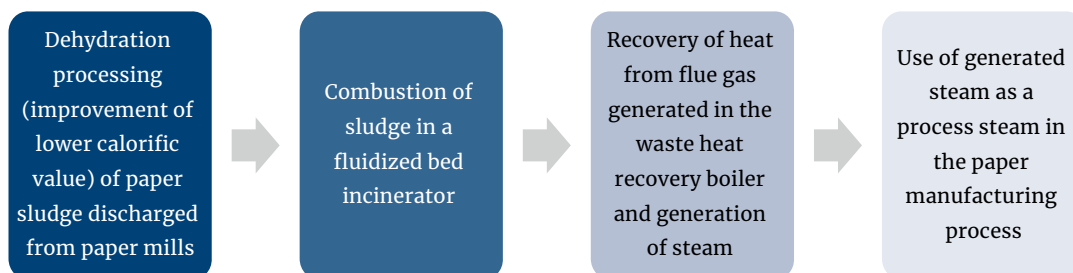
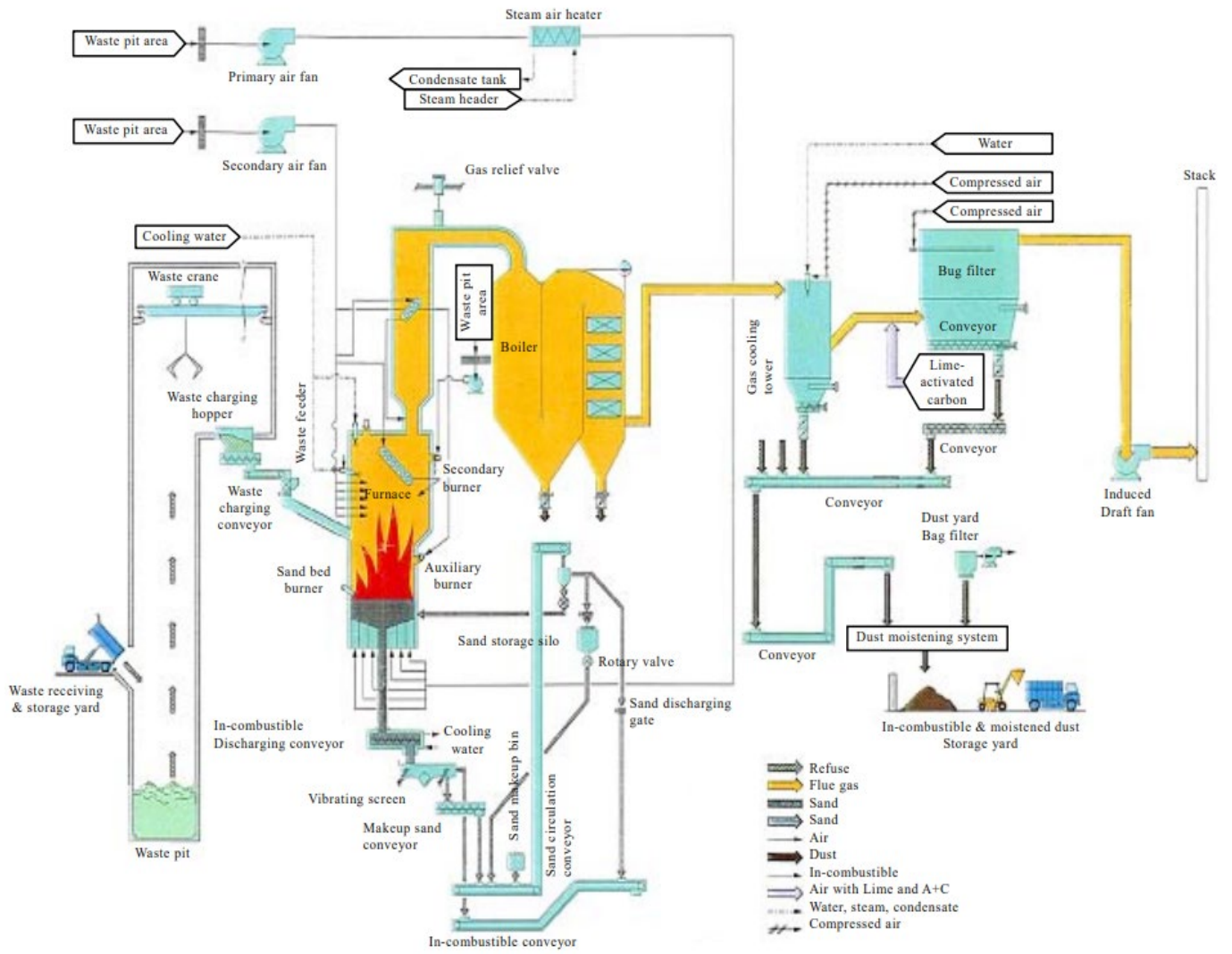

Figure 40 illustrates an overall view of paper sludge incineration plant. Paper sludge dehydrated to approximately 55 % moisture is fed into the incinerator hopper and incinerated sequentially in the incinerator heated at 600 degree celcius or higher. Non-burnable fractions in the incinerator are discharged from

the bottom of the incinerator together with fluidizing sand, which is cyclically used. Since the temperature of flue gas when incinerating becomes 850 - 950 degree celcius, the boiler recovers the heat and generates steam. This steam is used as steam for the paper manufacturing process.

Flow diagram of incineration plant



Source: (NEDO, 2003)

4.12.3 Potential Energy Savings and Greenhouse Gas Emission Reduction

One tonne of reject (from mills without de-inking) with about 45 % water content can substitute 0.7 tonnes of brown coal in the boiler. In a German plant with 370,000 t/year production capacity, incineration of rejects in a hearth combustion (with a capacity of 28,000 t/year) that is integrated in the power plant of the mill, led to a fossil fuel reduction of 66,000 MWh (The Institute for Industrial Productivity, 2016). At another factory with a capacity of dry paper

sludge of 110 t/day, energy amounting to 90,000 MWh/year was saved (New Energy and Industrial Technology Development Organization, 2008).

The investment cost for a incineration plant including facilities for reject pretreatment, drying and the gasification chamber for a reject volume flow rate of maximum 3 t/hour is estimated to be around € 2.5 million.

Key facts of measure – Waste Incineration Plant	
Investment Cost:	€ 2.5 million
Energy Savings:	The occurrence of savings depends on the general conditions of the components. 60,000 - 90,000 MWh/year
CO ₂ mitigation:	100,000 t _{CO2} /year
Advantage:	<ul style="list-style-type: none"> • Reduction of weight leading to lower transport and landfill costs • Feasible waste management option • Energy recovery
Disadvantage:	<ul style="list-style-type: none"> • High investment cost

4.13 Biogas from Sewage Plant

4.13.1 Description of Baseline Situation and Energy Consumption

Wastewater is a by-product of pulp and paper mills. Depending on the local conditions, different water purification techniques are used, such as combinations of sedimentation, biological treatment, chemical precipitation, flotation, and anaerobic treatment.

Some organic material ends up in the process water during the paper manufacturing processes; resulting in polluted water that requires purification. Some of

the dissolved organic material is utilized in biological wastewater treatment for the growth of various micro-organisms. These micro-organisms are readily separated from water and will then form sludge. The figure below presents wastewater treatment in some detail and shows the points of origin for the three most common types of sludge produced in wastewater treatment.

Illustration of wastewater treatment sites and nomenclature of pulp and paper mill sludge

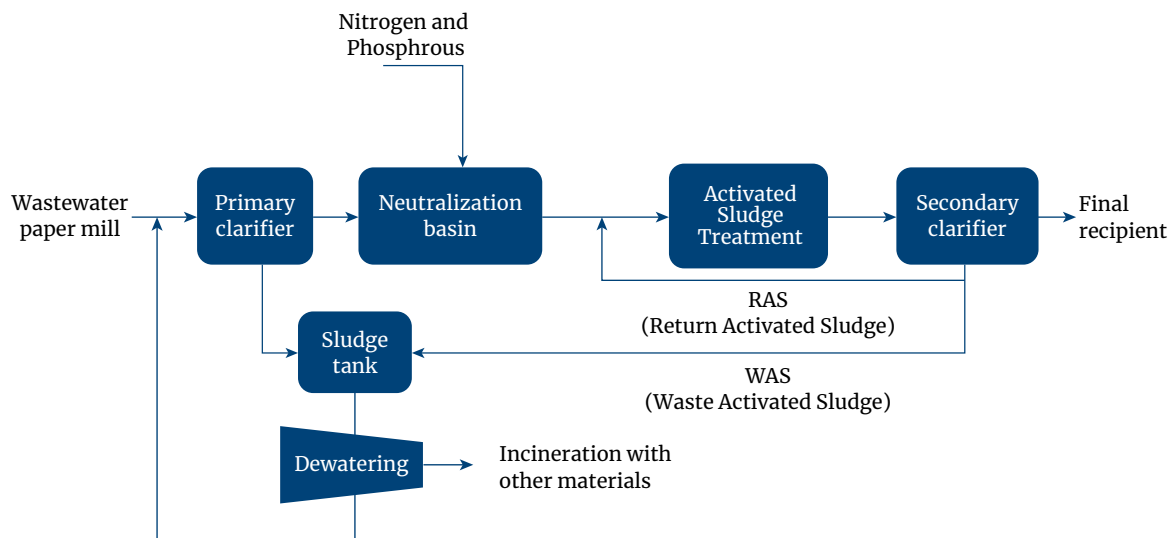

Source: (Scandinavian Biogas, 2019)

Traditionally, paper mill sludge is disposed of at landfills. The sludge from the primary treatment unit is mainly composed of fibers, fines, and fillers. The re-

sult of the secondary treatment will be either bio-sludge from bio-treatment or chemical-flocculation sludge from chemical flocculation treatment or both.

4.13.2 Suggested Measure of Improvement

By modifying the aerobic step of the wastewater treatment for increased production of bio-sludge, also known as waste activated sludge, significant energy savings will be obtained. The produced bio-sludge will be used as a substrate for biomethane production through anaerobic digestion (AD). In anaerobic biological wastewater treatment, the biologically degradable load is reduced in the absence of oxygen by digestion

by microorganisms, mainly generating methane and carbon dioxide. Different process designs are available. The main reactor types applied are fixed bed reactor, sludge contact process, anaerobic up-flow sludge blanket (UASB), expanded granular sludge blanket (EGSB), and, more recently, internal circulation (IC) reactors (Suhr, et al., 2015).

A significant development in AD technology linked to the base concept of UASB has been observed in the last decades. The new solutions are typically smaller and with lower cost for installation and maintenance thanks to the condition of operation preventing corrosion and clogging problems. This opens up for an increased interest in technical solutions where wastewater with high soluble COD (sCOD) content is processed

to biogas prior to aerobic treatment (activated sludge treatment) (Scandinavian Biogas, 2019).

A simplified scheme of a combined anaerobic-aerobic wastewater treatment plant is shown in Figure 42. The implementation of anaerobic wastewater treatments allows an increased capacity wastewater treatment capacity and decreased chemical needs.

Illustration of wastewater treatment sites and AD at a pulp and paper mill

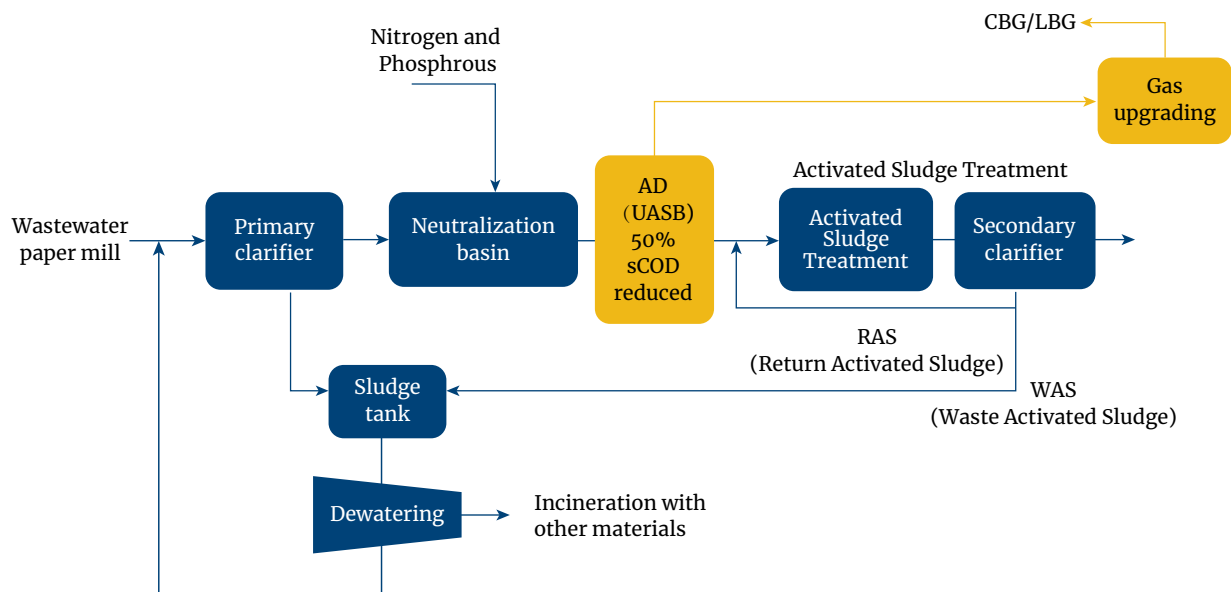

Source: (Scandinavian Biogas, 2019)

Applied in a pulp- and paper mill in Norway, the ongoing demonstration project “EffiSludge for LIFE” lowers the wastewater treatment (WWT) energy consumption while turning residual waste (bio-sludge) into energy by implementing a new wastewater treatment concept. EffiSludge for LIFE considers the sludge as a resource for biogas production. This makes a shift from minimizing to maximizing sludge production, thus reducing both the need for aeration and the retention time in the wastewater treatment (low sludge age). The following figure illustrates the EffiSludge concept where biogas is generated from waste-activated sludge and nutrients are recirculated into the activated sludge process (ASP). Key targets of the implementation of EffiSludge are:

- To decrease the residence time of the sludge (sludge age) and increase the organic loading rate of the aerobic treatment.
- To reduce the need for aeration in the aerobic treatment generating significant energy savings and thus reducing the carbon footprint of the aerobic wastewater treatment.
- To generate bio-sludge to be used as a substrate for biogas production. The bio-sludge can be digested as a single substrate or co-digested with other onsite or offsite substrates (Scandinavian Biogas, 2019).

EffiSludge concept

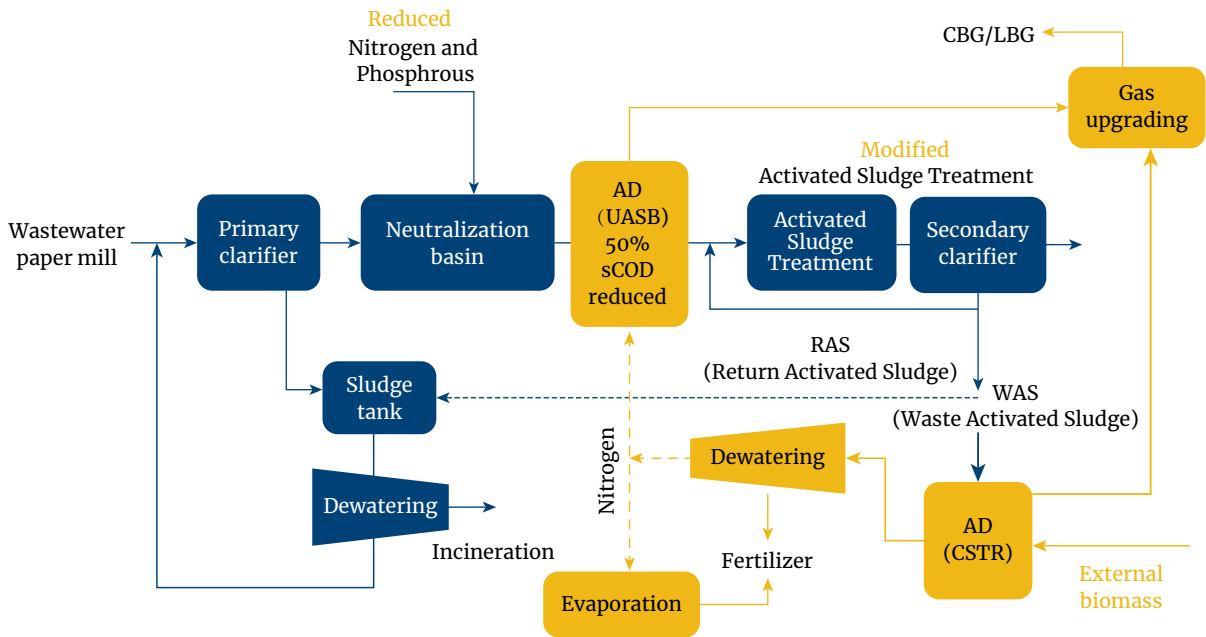

4.13.3 Potential Energy Savings and Greenhouse Gas Emission Reduction

The major impact on carbon emissions in the EffiSludge implementation comes from reducing electricity needed to aerate the biological WWT step. The maximum current carbon footprint from the parts of the WWT process was 9.6 – 13 kg CO₂-eq/kg pulp and the estimated future carbon footprint when implementing

the EffiSludge concept was estimated as 3.6 – 5.9 kg CO₂-eq/kg pulp. A reduction of 6 – 8 kg CO₂-eq/kg pulp could be expected by implementing the EffiSludge concept. In addition, biogas will be produced replacing fossil fuel and saving CO₂.

Key facts of measure – Biogas from Sewage Plant	
Investment Cost:	The economic feasibility and energy savings depends on the site and plant
Energy Savings:	
CO ₂ mitigation:	500 gr CO ₂ per m ³ of wastewater (Scandinavian Biogas, 2019)
Advantage:	<ul style="list-style-type: none"> • Feasible waste management option • Energy recovery • Increasing capacity wastewater treatment • Decreasing chemical needs • Reducing CO₂ eq/kg pulp
Disadvantage:	<ul style="list-style-type: none"> • High investment cost • Space requirement

4.14 Combined Heat and Power Production

4.14.1 Description of Baseline Situation and Energy Consumption

In paper mills different kinds of cogeneration processes are already used. Besides the classic back-pressure type steam power plants, since 1980 combined cycle utilities have been on the market. The back-pressure type steam power plant can reach a power to heat ratio of about 0.2 which is not sufficient for covering the electricity demand of modern paper production facilities. State-of-the-art paper machines need a power to heat ratio between 0.3 and 0.65 depending on the paper type, quality and pulp production facilities (for mechanical pulp mills, even higher) (Suhr, et al., 2015).

According to a market assessment of cogeneration in China, all wood-pulp papermaking factories have cogeneration plants, while the majority of straw-pulp papermaking factories do not. Parts of straw-pulp papermaking factories with a yield of 30,000 tonnes per year use boilers that burn black liquor for recovering alkali. But only a few have set up self-sufficient cogeneration plants. Instead, most have self-sufficient boilers. A few straw-pulp papermaking factories procure heat from district cogeneration plants (China Energy Conservation Investment Corporation, 2001).

4.14.2 Suggested Measure of Improvement

The combination of significant and steady process steam demand, high on-site electricity demand, high annual operating hours, and on-site generated fuels (i.e., wood waste and black liquor) has made Combined Heat and Power (CHP) an operationally and financially attractive option for many mills around the world.

Traditional steam power plants may increase the power output by retrofitting the steam cycle and arranging a gas turbine upstream of the boiler, which is then called a combined cycle gas turbine.

Combined heat and power (CHP), also called cogeneration, is an integrated set of technologies for the simultaneous, on-site production of electricity and heat. CHP units use the fuel for efficient production of steam and electricity in an energy cascade system. Cogeneration plants increase the conversion rate of fuel use (fuel efficiency level) from approx. 30 % in conventional power stations to around 80 – 93 %.

Diagram comparing losses from conventional generation vs. Cogeneration

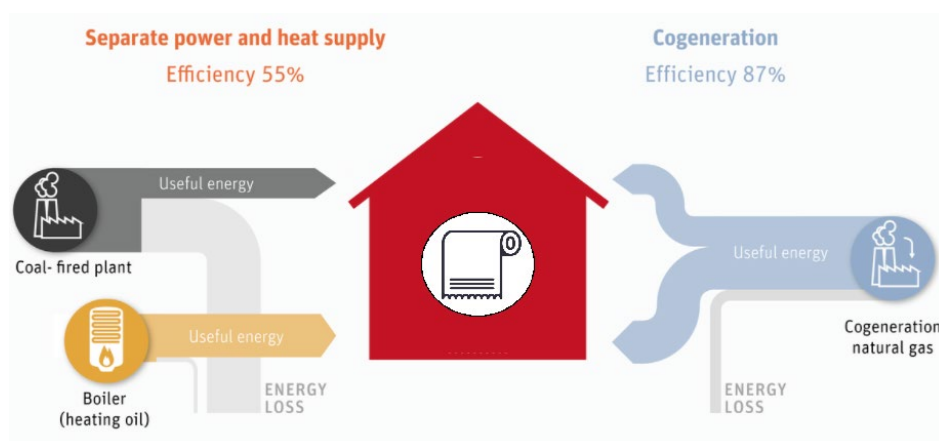

Source: Adopted from (Energy Transition, 2021)

Combined heat and power (CHP) plants in the pulp and paper industry typically consist of steam turbines and/or gas turbines (GT). Steam turbines are connected to a boiler producing high-pressure steam and fired by any type of fuel (black liquor, bark, waste, liquid, solid, or gas fuels). Typical CHP plants using fossil fuel or bio-fuels (i.e., most pulp mills), have a power to heat ratio of approximately 0.30 (Suhr, et al., 2015).

The capacities for CHP production differ from <math><1\text{ MW}_{th}</math> for small paper mills up to >math>500\text{ MW}_{th}</math> for the recovery boilers of large pulp mills. Figure 45 shows an example of CHP in the paper industry. The boiler, in this case a bubbling fluidized bed boiler, can be of any type and fuel. Either an extracting back-pressure turbine (Option A in the figure), a condensing turbine (Option B in the figure) or both can be used.

Example of a CHP plant at a pulp/paper mill

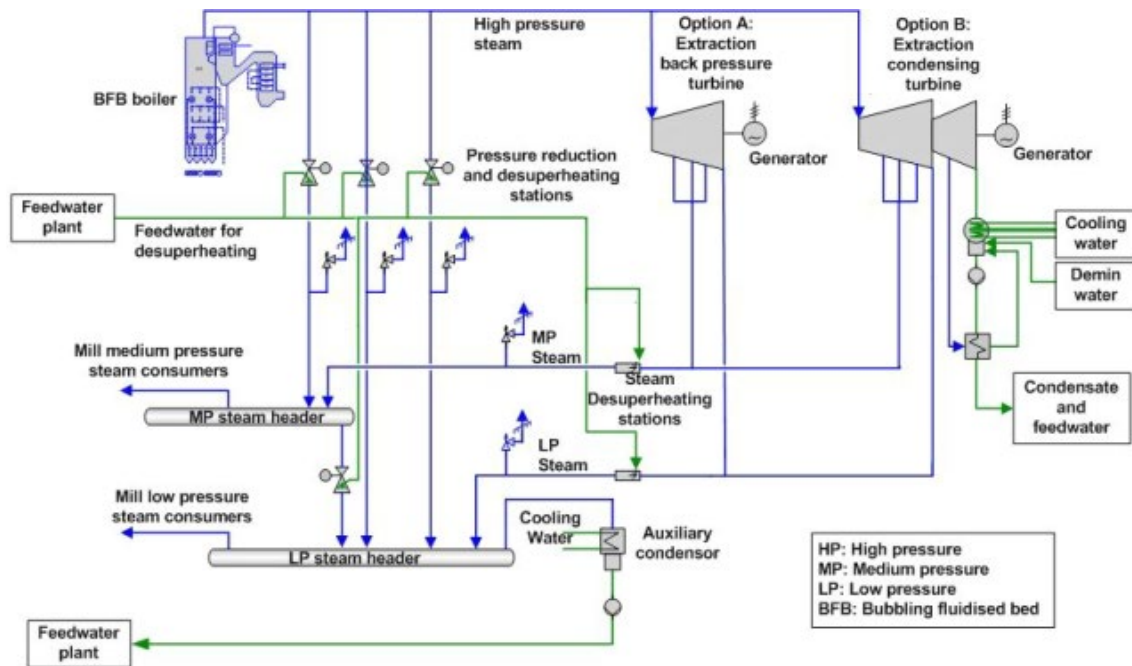

Source: (Suhr, et al., 2015)

4.14.3 Potential Energy Savings and Greenhouse Gas Emission Reduction

Benefits of CHP units include a higher energy efficiency, and consequently reduced emissions per kWh produced or per MJ fuel input, compared to separate power and heat generation. The installation of CHP can reduce the consumption of primary energy by 10 % to 15 %, resulting in a decrease in CO₂ emissions. Losses in the electricity distribution system is reduced to 5 % (Suhr, et al., 2015).

The table below, provides an example of the environmental performance of a combined cycle gas turbine

utility (CCGT) for mid-load operating public utility supply in Germany. The CCGT example represents a cogeneration process with the best possible thermal efficiency. The combined cogeneration of steam and power with 92 % fuel efficiency is compared with purchased electricity generated by a state-of-the-art coal-fired utility (42 % electrical efficiency, in the German example) and an on-site steam block (88 % boiler efficiency). In this example, oxygen content in the flue gas is 3 %.

Comparison of the environmental performance of a combined cycle gas turbine plant and a public utility supply in Germany

Example of a combined cogeneration plant designed for 95 t steam/h; production of approximately 90 t steam/h; 24 MW _e output [1]					mg/MJ
	Unit			Value	NA
Power output combined	MW			24.0	NA
Process heat combined	MW			60.0	NA
Power to heat ratio	MW/MW			0.40	NA
Total generated energy	MJ/h			302 400	NA
		Utility			
	Unit	Gas turbine	Supplemental firing	Total	mg/MJ
Rated thermal input	MW	37.9	53.6	91.5	NA
Gas flow (dry gas, normal conditions)	m ³ /h	NA	NA	109 000	NA
Emission NO _x	mg/m ³	NA	NA	70	NA
Emission CO	mg/m ³	NA	NA	5	NA
Emission SO ₂	mg/m ³	NA	NA	0	NA
Mass flow NO _x	kg/h	NA	NA	10.9	36.0
Mass flow CO	kg/h	NA	NA	0.5	1.8
Mass flow SO ₂	kg/h	NA	NA	0	0
Mass flow CO ₂	t/h	NA	NA	19.0	62 830
Purchased electricity: 24 MW from coal-fired mid-load operating public utility - process steam is generated by a steam block 90 t/h [2]					
	Unit			Value	mg/MJ
Purchased power	MW			24	NA
Heat generation	MW			60	NA
Total generated energy	MJ/H			302 400	NA
		Utility			
	Unit	Electricity generation	steam generation	Total	mg/MJ
Rated thermal input	MW	59.4	67.6	127	NA
Cas flow (dry, normal)	m ³ /h	73 070	69 030	142 100	NA
Emission NO _x	mg/m ³	200	100	NA	NA
Emission CO	mg/m ³	200	50	NA	NA
Emission SO _x	mg/m ³	200	0	NA	NA
Mass flow NO _x	kg/h	14.6	6.90	21.5	71.1
Mass flow CO	kg/h	14.6	3.45	18	59.7
Mass flow SO ₂	kg/h	14.6	0	14.6	48.3
Mass flow CO ₂	t/h	19.6	13.9	33.6	110950
NB: NA = not available					
⁽¹⁾ Oxygen content in the waste gas is 3%					
⁽²⁾ Calculation for conversion of the figures into specific values: 1 MW × 3 600 = MJ/h; e.g. (24.0 + 60.0) × 3 600 = 302 400 MJ/h; For example, the specific NO _x Emissions can be calculated as 10 900g/h divided by 302 400 MJ/h = 36mg/MJ.					

Source: (F.Hutter, 2010)

In this example, 49 % reduction in NO_x, 97 % reduction in CO, 100 % reduction in SO₂, and 43 % reduction in CO₂, are achieved.

CHP is applicable to both new and existing mills. Administrative procedures regarding obtaining permits required to build the plant may constitute an obstacle for implementing CHP. In existing plants, cogeneration can be implemented, for instance, by re-powering existing steam back-pressure units and transforming them into combined cycle cogeneration plants.

The achievable savings and the payback time depend mainly on the price of electricity and fuels within the country. Investment costs for CHP depend on the size of the plant. Capital investments per MW installed decrease with plant size and depend on the CHP technology installed. According to size and technology following capital investments were reported:

Capital investments required in 2010 according to size and technology

Technology	Specification	Investment
Simple cycle with gas turbine	1 MW and production of 3 t/hr of saturated low-pressure steam	€ 1,5 million
	4.5 MW and production of 6 t/hr of saturated low-pressure steam	€ 5 million
Simple cycle with engine	1 MW with steam or cold production	€ 1.3-1.5 million
Combined cycle with a gas turbine (CCGT)	25 MW and production of 40 t/hr of saturated low-pressure steam	€ 30 million
	48 MW and production of 90 t/hr of saturated low-pressure steam	€ 54 million

Source: (ASPAPEL/CELPA, 2010)

Key facts of measure – Combined heat and power production	
Investment Cost:	See Table 27
Energy Savings:	10 – 15 % reduction
CO ₂ mitigation:	43 % reduction (Table 25)
Advantage:	<ul style="list-style-type: none"> • Increase in energy efficiency • Reduction in power costs • Emission reduction
Disadvantage:	<ul style="list-style-type: none"> • High investment cost • Complex implementation and operation

4.15 Outlook on Further Developments

In the technology map of the European Strategic Energy Technology Plan (European Commission Joint Research Centre (JRC), Institute for Energy and Transport, 2011) potential breakthrough technologies in the pulp and paper sector are classified into three groups:

- Further development of **innovative drying technologies** (including “impulse drying”, “condebelt” process, and “steam impingement drying”)
- Optimisation of **mechanical pulping** via focusing on the wood yield preparation and more efficient refiner plates
- Development of mills towards integrated **bio-refinery** complexes

In addition to above measures, further developments of simulations and digitalisation towards **Digital Twins** can be highlighted.

Due to the potential impacts on the overall pulp and paper industry, this report will focus on the latter two developments.

4.15.1 Digital Twins

Further optimisation of the pulp and paper making process is often linked to digitalization and monitoring technologies. E.g. an optimization project co-funded by the ECO-innovation initiative (ASTEPP, Advanced Sensing Technologies for Paper Production) carried out 2014-2016 (www.astepbycristini.it) pointed at the reduction of greenhouse gas emissions of 5.5 % besides substantial water savings and decreasing material loss. This was achieved via the use of a new generation of advance sensors able to monitor the different phases of the paper production process.

For manufacturing applications, Digital Twins go beyond the mere optimization of single tools and computer-based simulations of single processes, which have already been in place since the 1980s. As per definition a Digital Twin “simulates the interrelated processes of an entire pulp mill and connects these in real time to the mill’s physical operation”. (Nazari, 2018). Digital Twins are one of the core components of cyber-physical systems, which form part of industry 4.0 (internet of things), together with artificial intelligence and advanced analytics. Digital Twin appli-

cations can provide valuable conclusions both for the design and operations phase while measuring the conditions or physical characteristics of a process and real-time effects on the overall mill. Optimisation in any aspect (time, material, energy) as well early detection of any problems which would remain undiscovered otherwise can be performed.

According to the results of a recent survey in Germany, approximately half of the bigger industrial enterprises plan to implement Digital Twins in the year 2021. Aim is to monitor assets and processes and continuously improve complex industrial facilities, machines, as well as services and processes. Only 7 % of the surveyed participants (170 participants from top or middle management from 10 branches) do not see any efficiency gain via the implementation of Digital Twins. It is expected that the use of Digital Twins will almost double within the next five years. Moreover, it is expected that the majority of Digital Twins (80%) are used across different enterprises (and not only within one business) (Uwe Weber, 2019).

4.15.2 Biorefineries

Biorefineries extend the scope of processes and outputs in comparison to “regular” mills and can be defined as *plants that fully utilize the incoming biomass and other raw material for simultaneous and economically optimized production of fibres, chemicals and energy* (adapted from: (Swedish Energy Agency, 2008)).

Potential products (apart from the traditional fibre products) include:

- Chemicals and materials such as phenols, adhesives, carbon fibres, pharmaceuticals etc.
- Biofuels (pellets, methonal, Dimethylether - DME, ethanol etc.)
- Electricity (Condensing power, BLGCC).

In a traditional chemical pulp mill, the three major components of wood (cellulose, hemicellulose and lignin) are used to produce fibres and electricity/steam; in a biorefinery part of the lignin and/or hemicellulose is used for other products. It is assumed (ibid) that there is a high potential to increase biofuel excess in future chemical market pulp mills due to new efficient technologies, process integration and new system solutions. Moreover, increasing energy prices and policy instruments are not only calling for energy efficiency, but also resource efficiency improvements making biorefineries a promising option.

The following chart provides an overview of biomass treatment in a biorefinery:

Dryer cylinder and stationary syphon

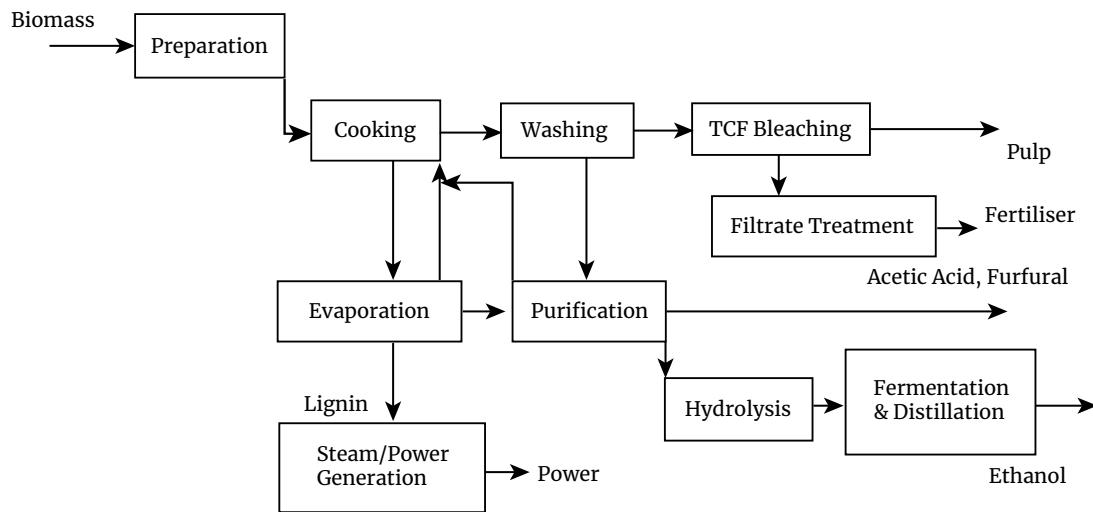

Source: (Arumugam, 2015)

In comparison, in pulp mills, unselective fractionation leads to the fact that substantial hemicellulose fraction is burnt together with lignin to produce steam; this way only about 60 % of the biomass is used.

In general, different types of mill integration exist; biorefineries with focus on the production of chemicals and materials, or with focus on energy production (electricity or lignin production, production of upgrade biofuels or electricity production using gasification (e.g. methanol or dimethylether DME)).

In general, cooperation of pulp and paper industry with other energy consuming industries could lead to overall energy/resource efficiency improvements. Potential cooperations include

- Utilising pulp mill excess heat for drying/pelletizing biomass (potentials are estimate at 1 - 1.5 GJ/ADt)
- Using acid leaching of forest residues and thus making them more interesting as fuel in limekilns, (which reduces ash content and environmental/incineration problems)
- Energy supply for other industries which have a large heat demand at low temperature.

In biorefineries with focus on the production of chemicals and materials, organic compounds from pulp mills (such as black liquor and bark) could be processed into chemicals or new raw materials, instead of being incinerated in the recovery boiler. Chemicals comprise recovered lignin, which can be further used as binder, road additive or in batteries, but there is also ongoing research to use it in carbon fibres. Recovered hemicellulose can be used as fibre additives, improving the fibre-to-fibre bonding ability of pulps, as well as hydrogels (encapsulation of living cells) or furfural which can be used for different types of plastics. (Swedish Energy Agency, 2008)

As an example, Chempolis (a Finnish company, see www.chempolis.com) developed and patented third generation technologies for biorefining of non-food biomasses, runs a pilot-scale biorefinery and currently develops a refinery in India. According to their own description, bioethanol, high quality pulps like dissolving pulp, cellulosic sugars, biochemicals and sulfur free lignin can be produced sustainably from all lignocellulosic raw materials (hardwood and softwood, non-wood and non-food biomasses such as straw, bagasse, corn stover, EFB and bamboo) using about 90 % of the biomass.



5

Conclusions

Pulp and paper production is very energy-intensive process and there is a wide range of measures throughout the whole production process to improve energy and resource efficiency of the mills and to reduce CO2 emissions.

The following table summarizes the most promising measures which are either easy-to-implement or have a high potential. Details are presented in the respective subchapters of the report.

Measures	Key facts of measures				
	Investment Cost	Energy Savings (thermal and electricity)	CO ₂ mitigation	Advantage	Disadvantage
Batch Digester Improvement ((Indirect Heating and Cold-Blow Technology))	4.80 €/productpulp	880 kWh/tp _{product}	0.3 t CO ₂ /tp _{product}	<ul style="list-style-type: none"> Increased capacity (up to 30 %) Reduced fuel consumption (oil, natural gas, etc.) Reduced energy consumption Low risk of hydrogen sulfide 	<ul style="list-style-type: none"> High cost of replacement Costly maintenance
Lime Kiln Modification, Oxygen Enrichment	less than € 100,000 (Focus on Energy, 2006)	7 - 12 % fuel reduction (25 - 40 kWh/t pulp)	0.01 - 0.02 tCO ₂ /tpulp	<ul style="list-style-type: none"> Increased capacity (up to 30 %) Reduced fuel consumption (oil, natural gas, etc.) Reduced energy consumption Low risk of hydrogen sulfide 	<ul style="list-style-type: none"> High investment High running costs
Lime Kiln Modification, High-Performance Refractory	The difference in cost between standard and high-performance refractory is less than 15,600 € for a typical kiln (Focus on Energy, 2006)	5 % fuel reduction (17 kWh/t pulp)	0.007 t CO ₂ /tpulp	<ul style="list-style-type: none"> The potential of a “gunned” application, less time for implementing Reduced fuel consumption (oil, natural gas, etc.) 	<ul style="list-style-type: none"> Only applies to mills with lime kilns (i.e. Kraft mills)
Black Liquor Evaporator (Solids Concentrator)	Depending on the concentration increase rate, between 1.7 - 9.0 million € The ROI on this type of installation is estimated at 7 % to 14 %.	59 kWh/tblack liquor	0.023 t CO ₂ /tblack liquor	<ul style="list-style-type: none"> Thermal efficiency Lowers sulfur compound emissions Reliability of the recovery process Improve productivity by 2 % 	<ul style="list-style-type: none"> Increases emissions of particulates prior to flue-gas cleaning, requires installation of more efficient and expensive electrostatic precipitator

High Efficiency Refiner	600,000 €	7 – 20 % electricity saving depending on the application 20-45 kWh/tpaper	0.012 - 0.03 t CO ₂ /tpaper	<ul style="list-style-type: none"> • Saving power due to lower no-load power • Cost reduction • Improvement of product quality is possible 	<ul style="list-style-type: none"> • High investment costs • The capacity of the feed pump, refining and storage chests may need to be adapted to ensure a reliable operation.
Radial blowers	Case-specific, less than 2 years payback time	20-30 kWh/tpaper	0.008 – 0.012 t CO ₂ /tpaper	<ul style="list-style-type: none"> • Cost reduction due to steam savings • Increase in production rate • Higher drying capacity 	<ul style="list-style-type: none"> • Corrosive potential
Thermo-Compressors	Case-specific, payback time is less than one year	25 kWh/tpaper	0.01 t CO ₂ /tpaper	<ul style="list-style-type: none"> • Energy savings for steam 	<ul style="list-style-type: none"> • Increase need of high pressure steam
Paper Machine Hood	From 1 – 2 years payback time	Savings in the order of 3,200 kWh per hour 200 kWh/tpaper	0.07 t CO ₂ /tpaper	<ul style="list-style-type: none"> • Saving energy • Reduce exterior ice accumulation and stack noise emissions 	<ul style="list-style-type: none"> •
Shoe Press	10 million € including the installation for a paper machine of 5 m	60-180 kWh/tpaper by 1%-3% dryness increase after the press	0,01-0,07 t CO ₂ /tpaper	<ul style="list-style-type: none"> • Higher after-press dryness • Reduce thermal drying requirements • Opportunity to save bulk • Better final product quality • Increase in production 	<ul style="list-style-type: none"> • High investment cost • Space requirement within the machine
Stationary Siphon and Drying Bar	Typically mills installing this technology see ROIs in the 25 to 80 % range.	250 kWh/t	0.1 t CO ₂ /tpaper	<ul style="list-style-type: none"> • Minimizes the steam consumed in drying paper 	<ul style="list-style-type: none"> • High investment cost • Time consuming implementation
Steam Traps Maintenance	0.91 €/t product	497 kWh/t product	0.19 t CO ₂ /tpaper	<ul style="list-style-type: none"> • Increasing production safety 	<ul style="list-style-type: none"> • -
Real-Time Energy Management System	3.22 €/t product	111 kWh/t product	0.04 t CO ₂ /tpaper	<ul style="list-style-type: none"> • Increasing resource and energy efficiency • Reducing maintenance costs • Reducing processing time 	<ul style="list-style-type: none"> • -

<p>Energy-efficient frequency inverter for pumps, fans, and compressors</p>	<p>0.69 €/t product</p>	<p>10.5 kWh/t product</p>	<p>0.006 t CO₂/tpaper</p>	<ul style="list-style-type: none"> • Cost reduction • Energy savings (power) • Process control 	<ul style="list-style-type: none"> • -
<p>Drying of Bio-fuel and Sludge Utilizing Excess Heat</p>	<p>achievable savings and investment costs depend on specific mill characteristics and energy source for drying</p>			<ul style="list-style-type: none"> • Reduction of weight leading to lower transport and • landfill costs • To increase the calorific value prior to incineration 	<ul style="list-style-type: none"> • Extracted humidity may cause an odour problem and • needs to be controlled
<p>Waste Incineration Plant</p>	<p>2.5 million €</p>	<p>The occurrence of savings depends on the general conditions of the components. 60,000 - 90,000 MWh/year</p>	<p>100,000 t CO₂/year</p>	<ul style="list-style-type: none"> • Reduction of weight leading to lower transport and • landfill costs • Feasible waste management option • Energy recovery 	<ul style="list-style-type: none"> • High investment cost
<p>Biogas from Sewage Plant</p>	<p>The economic feasibility and energy savings depends on the site and plant</p>			<p>500 gr CO₂ per m³ of wastewater (Scandinavian Biogas, 2019)</p> <ul style="list-style-type: none"> • Feasible waste management option • Energy recovery • Increasing capacity wastewater treatment • Decreasing chemical needs • Reducing CO₂ eq/kg pulp 	<ul style="list-style-type: none"> • High investment cost • Space requirement
<p>Combined heat and power production</p>	<p>See Table 27</p>	<p>10 – 15 % reduction</p>	<p>43 % reduction (Table 25)</p>	<ul style="list-style-type: none"> • Increase in energy efficiency • Reduction in power costs • Emission reduction 	<ul style="list-style-type: none"> • High investment cost • Complex implementation and operation

Literature

- Arumugam, A. (2015, March). Development in bio-refinery and its impact on pulp and paper industry. *IPPTA: Quarterly Journal of Indian Pulp and Paper Technical Association*, pp. 92-101.
- ASPAPEL/CELPA. (2010). *Environmental issues specific to eucalyptus-based kraft pulp making*.
- Bhutania, N., Lindberg, C.-F., Starr, K., & Horton, R. (2012). *Energy assessment of Paper Machines*. Energy Procedia.
- Blum et al. (2009). *Revision of best available technique reference document for the pulp & paper industry*. München: Federal Environmental Agency Germany.
- Bruno Lapillonne, K. P. (2018). Regional training on indicators « ODYSSEE-MURE » 2. Energy efficiency trends by sector: ODEX.
- China Energy Conservation Investment Corporation. (2001). *Market assessment of cogeneration in china*. Energy Resources International, Inc.
- Elaahi, A., & Lowitt, H. (1988). *The U.S. Pulp and Paper Industry: An Energy Perspective*. Washington, DC: U.S. Department of Energy.
- Energy Transition. (2021). *energytransition*. Von energytransition.org abgerufen
- European Commission. (2018, last update 12/2020). *Clean energy for all Europeans package*. Von https://ec.europa.eu/energy/topics/energy-strategy/clean-energy-all-europeans_en#energy-efficiency abgerufen
- European Commission. (2021). *COMMISSION IMPLEMENTING REGULATION determining revised benchmark values for free allocation of emission allowances for the period from 2021 to 2025 pursuant to Article 10a(2) of Directive 2003/87/EC of the European Parliament and of the Council (draft)*.
- European Commission Joint Research Centre (JRC), Institute for Energy and Transport. (2011). *2011 Technology Map of the European Strategic Energy Technology Plan (SET Plan)*.
- Ewijk, S. v., Stegemann, J. A., & Ekins, P. (2021). Limited climate benefits of global recycling of pulp and paper. *Nature sustainability* 4, S. 180–187.
- F.Hutter. (2010). *Data related to the environmental performance of the recently built CCGT plant at the paper and cartonboard mill in RCF DE 2*. Germany.
- Fawkes, S. O. (2016). *Best Practices and Case Studies for Industrial Energy Efficiency Improvement – An Introduction for Policy Makers*. Copenhagen: UNEP DTU Partnership.
- Focus on Energy. (2006). *Pulp and Paper Energy Best Practice Guidebook*. Madison, Wisconsin.
- Fraunhofer ISI. (2018). *Energy Efficiency Trends and Policies in Germany – An Analysis Based on the ODYSSEE and MURE Databases*.
- Gardner. (2008). *Steam Traps & Condensate Systems: How to Maximise a Steam System's Safety, Reliability and Efficiency*. Amsterdam.
- Hagelqvist, A. (2013). *Sludge from pulp and paper mills for biogas production*. Karlstad University Studies.
- IEA. (2018). *IEA data and statistics*. Von <https://www.iea.org/data-and-statistics> abgerufen
- IGES (Institute for Global Environmental Strategies). (2021). *Grid Emissions Factors (GEF) Published by Country Government or Adopted as CDM Standardized Baseline V10.10*.
- ILO Encyclopaedia. (2021). *Workplace Health and Safety Information*. Von <http://www.ilocis.org/documents/chpt72e.htm> abgerufen

Kramer, K., Masanet, E., Xu, T., & Worrell, E. (2009). *Energy Efficiency Improvement and Cost Saving Opportunities for the Pulp and Paper Industry*. Berkeley, CA: Lawrence Berkeley National Laboratory.

Kurita. (2021). *Kurita Water Industries Ltd*. Von https://www.kurita.co.jp/english/our_business/business/pulp_and_paper.html abgerufen

Lemmetti, A., Murtovaara, S., Leiviskä, K., & Sutinen, R. (1999). *Cooking Variables Affecting the Kraft Pulp*. University of Oulu.

Lenntech. (kein Datum). *Lenntech*. Von <https://www.lenntech.de/papier-und-pulpindustrie.htm> abgerufen

Lingbo Kong, A. H. (2013). *Analysis of Energy-Efficiency Opportunities for the Pulp and Paper Industry in China*. China Energy Group, State Key Laboratory of Pulp and Paper Engineering; Ernest Orlando Lawrence Berkeley National Laboratory.

Luiten, E. (2001). *Beyond energy efficiency. Actors, networks and government intervention in the development of industrial process technologies*. Utrecht, the Netherlands.

MacGregor, M. (1989). *Wet pressing research in 1989. An historical perspective, analysis and commentary*. Cambridge: Fundamentals of Paper Making, Proceedings of the 9th Fundamental Research Symposium.

Martin, N., Anglani, N., Einstein, D., Khrushch, M., Worrell, E., & Price, L. (2000). *Opportunities to Improve Energy Efficiency and Reduce Greenhouse Gas Emissions in the U.S. Pulp and Paper Industry*. California: Lawrence Berkeley National Laboratory.

Mittal, A., Saxena, A., & Mohapatra, B. (2020). Oxygen Enrichment Technology—An Innovation for Improved Solid Fuel Combustion and Sustainable Environment. In K. Sangwan, & C. Herrmann, *Enhancing Future Skills and Entrepreneurship* (S. 13–19). Springer, Cham.

N.Adams, T. (kein Datum). *Lime Kiln Principles and Operation*. Washington.

NAF Control Valves. (2021). *Flowserve*. Von <https://naf.se/applications/chemical-pulping/fiberline/cooking/batch-digester/> abgerufen

National Council for Air and Stream Improvement (NCASI). (2001). *Technologies for Reducing Carbon Dioxide Emissions: A Resource Manual for Pulp, Paper and Wood Products Manufacturers*. Research Triangle Park.

Nazari, S. (2018). Andritz, IDEAS Digital Twin in Process Industries, Improving Pulp Mill Operation with Digital Twin Technology. *Tech News No 38/2*.

NEDO. (2003). *Model project of efficient use of paper sludge combustion waste heat*.

New Energy and Industrial Technology Development Organization. (2008). *Japanese Technologies for Energy Savings/GHG Emissions Reduction*. Japan.

Nygårds, E. (2016). *Experimental equipment for simulation of press nip in tissue paper machine*. Faculty of Health, Science and Technology, Karlstad University.

ODYSSEE Database. (2018). Von <https://www.odyssee-mure.eu/> abgerufen

Pumps and systems. (2021). *Pumps and systems*. Von <https://www.pumpsandsystems.com/> abgerufen

Sappi Fine Paper Europe. (2012). Von <https://www.slideshare.net/SappiHouston/paper-machine> abgerufen

Scandinavian Biogas. (2019). *Industrial wastewater treatment for biogas production*. Amsterdam.

Shenzhen Gozuk. (2021). *Gozuk*. Von <http://www.gozuk.com/applications/vfd-for-pumps.html> abgerufen

Staudt, J., Partners, A. T., Yelverton, W., Witosky, M., Torres, E., EPA, U., . . . International, R. (2010). *ISIS Emissions Control for Pulp and Paper Plants*.

Suhr, M., Klein, G., Kourti, I., Gonzalo, M. R., Santonja, G. G., Roudier, S., & Sancho, L. D. (2015). *Best Available Techniques (BAT) Reference Document for the Production of Pulp, Paper and Board*. Luxembourg: European Commission .

Swedish Energy Agency. (2008). *Swedish Pulp Mill Biorefineries, A Vision of Future Possibilities*.

The Institute for Industrial Productivity. (2016). *Pulp and Paper*. New Delhi.

Umwelt im Unterricht. (August 2018). *Papierherstellung, Papierkonsum und die Folgen für die Umwelt*. Von Umwelt im Unterricht: <https://www.umwelt-im-unterricht.de/hintergrund/papierherstellung-papierkonsum-und-die-folgen-fuer-die-umwelt/> abgerufen

UPM . (2020). *SO ENTSTEHT QUALITÄTSPAPIER*.

Uwe Weber, H. G. (2019). *Digitale Zwillinge - Wegbereiter für Ökosysteme von morgen*. Detecon Consulting.

Valmet Forward. (2021). *Valmet Forward*. Von <https://www.valmet.com/media/articles/up-and-running/performance/FPSPUG17/> abgerufen

Wahlstrom, B. (1991). *Pressing – the state of the art and future possibilities in Paper Technology*.

Website



Wechat

